

Mobilkran · Mobile Crane Grue automotrice

LG 1550

Technische Daten
Technical Data
Caractéristiques techniques

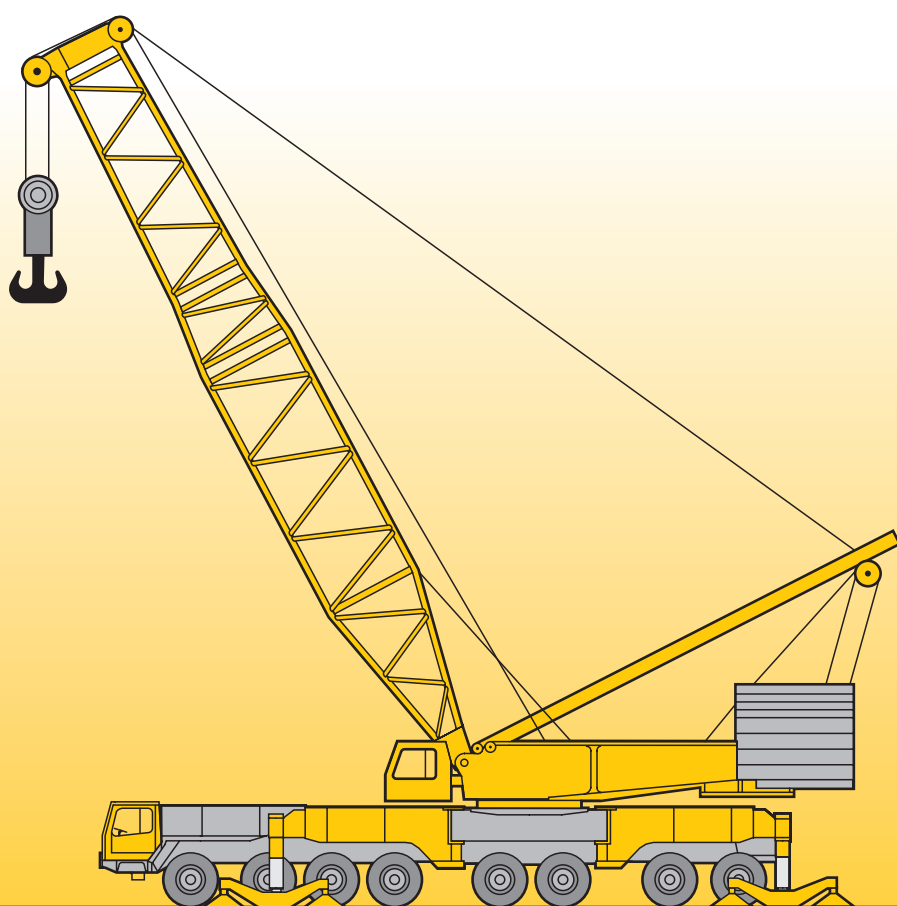

LIEBHERR

Technische Beschreibung

Technical description

Description technique

Kranfahrgestell

Rahmen	Eigengefertigte, verwindungssteife Kastenkonstruktion aus hochfestem Feinkorn-Baustahl.
Abstützungen	Vier hydraulisch ausklappbare Schwenkholme mit hydraulischen Abstützzyllindern und Drucktellern.
Motor	8-Zylinder-Diesel, Fabrikat Liebherr, Typ D 9408 TI-E A5, wassergekühlt, Leistung nach DIN 440 kW (598 PS) bei 2100 min ⁻¹ nach ECE-R 24.03 und 2001/27/EG (Euro 3), max. Drehmoment 2580 Nm bei 1200 min ⁻¹ – 1500 min ⁻¹ , Kraftstoffbehälter: 600 l.
Getriebe	Automatik-Getriebe, Fabrikat Allison, Typ CLBT 755, mit Drehmomentwandler und Strömungsbremse. 5 Vorwärts- und 1 Rückwärtsgang. Verteilergetriebe mit Verteilerdifferential mit Differentialsperre, Geländestufe.
Achsen	Schwere Kranfahrzeugachsen. Alle 8 Achsen gefedert. Achsen 1 bis 4 und 7 und 8 gelenkt. Achsen 1, 2, 5 und 6 sind Planetenachsen mit Differentialsperren.
Federung	Alle Achsen sind hydropneumatisch gefedert mit automatischer Niveauregulierung. Achsdruckausgleich zwischen allen Achspaaren. Federung hydraulisch blockierbar.
Bereifung	24fach. Achsen 1, 2, 5 und 6 einfach bereift, Achsen 3, 4, 7 und 8 doppelt bereift. Reifengröße: 14.00 R 25.
Lenkung	ZF-Halblock-Hydrolenkung, 2-Kreisanlage mit hydraulischer Servoeinrichtung und zusätzlicher Reservepumpe, von der Achse angetrieben.
Bremsen	Betriebsbremse: Allrad-Servo-Druckluftbremse, 2-Kreisanlage. Handbremse: Federspeicher auf alle Räder der 2. bis 7. Achse wirkend.
Fahrerhaus	Großräumige Kabine in Stahlblechausführung, gummielastisch aufgehängt, Sicherheitsverglasung, Kontrollinstrumente.
Elektr. Anlage	24 Volt Gleichstrom, 2 Batterien, Beleuchtung nach StVZO.

Kranoberwagen

Rahmen	Eigengefertigte, verwindungssteife Schweißkonstruktion aus hochfestem Feinkorn-Baustahl. Verbindung zum Fahrwerk über 3-reihige Rollendrehverbindung, 360° schwenkbar.
Motor	6-Zylinder-Diesel, Fabrikat Liebherr, Typ D 9406 TI-E, wassergekühlt, Leistung nach DIN 300 kW (408 PS) bei 1900 min ⁻¹ , max. Drehmoment 1710 Nm bei 1400 min ⁻¹ .
Kranantrieb	Hydraulisch über Pumpenverteilergetriebe mit 5 Axialkolben-Verstellpumpen mit Leistungsregelung, geschlossene Ölkreisläufe.
Kransteuerung	Servosteuerung mit elektronischer Gleichlauf-einrichtung, Energierecycling beim Senken der Last. Alle Bewegungen werden unabhängig voneinander über Kreuzsteuerhebel gefahren.
Winden	Winden hydraulisch angetrieben über Axialkolben-Verstellpumpen und Planetengetriebe. Lamellenbremsen federbelastet und hydraulisch lüftbar.
Drehwerk	Hydraulisch angetrieben über Axialkolbenpumpe und Planetengetriebe. Lamellenbremse federbelastet und hydraulisch lüftbar. Drehgeschwindigkeit stufenlos regelbar von 0 – 1,2 min ⁻¹ .
Gegengewicht	160 t, bestehend aus: 1 Grundplatte mit 16 t, 12 Teilen à 10 t und 4 Teilen à 6 t Gewicht. 40 t Zusatzballast als Option.
Krankabine	Stahlblechausführung mit Sicherheitsverglasung, seitlich schwenkbar und nach hinten neigbar, mit Bedienungs- und Kontrollinstrumenten.
Sicherheits-einrichtungen	LICCON-Überlastanlage, Hubendbegrenzung, Sicherheitsventile gegen Rohr- und Schlauchbrüche.
Elektr. Anlage	24 V Gleichstrom, 2 Batterien à 143 Ah.

Auslegersysteme

Ausführung	SL – SLD – SD – SW – SWN – SDW – SDWN.
Zusatzeinrichtung	Schwebeballast 250 t für SLDB – SDB – SDWB.

Technische Beschreibung

Technical description

Description technique

Crane carrier

Frame	Liebherr designed and manufactured, box type, torsion resistant, all-welded construction made of high-tensile structural steel.
Outriggers	4 hydraulic swing-out beams with support pad jacks.
Engine	Diesel, 8 cylinder, watercooled, make Liebherr, type D 9408 TI-E A5, output 440 kW DIN (598 HP) at 2100 min ⁻¹ acc. to ECE-R 24.03 and 2001/27/EG (Euro 3), max. torque 2580 Nm at 1200 min ⁻¹ – 1500 min ⁻¹ . Fuel tank capacity: 600 litres.
Transmission	Allison, type CLBT 755 automatic transmission with torque converter and hydrodynamic retarder brake, 5 forward speeds, 1 reverse. Splitter gearbox with differential and differential lock, off-road range.
Axles	Heavy-duty crane truck axles, all 8 axles sprung. Axles 1 to 4 and 7 and 8 steered. Axles 1, 2, 5 and 6 have planetary reduction gears with differential locks.
Suspension	All axles are hydropneumatically sprung with automatic levelling. Load equalization between all axle pairs. Suspension can be hydraulically locked.
Tyres	24 tyres. Axles 1, 2, 5 and 6 with single tyres, axles 3, 4, 7 and 8 with twin tyres. Tyre size: 14.00 R 25.
Steering	ZF semi-unitary hydraulic power steering with 2 pump circuits. Main pump circuit driven from enging, auxiliary pump circuit from final drive.
Brakes	Service brake: servo assisted air brakes acting on all wheels, dual circuit system. Hand brake: spring-action, acting on all wheels of axles 2 to 7.
Driver's cab	Large-area, all-steel cab with resilient mountings, safety glass windows and full range of instruments.
Electrical system	24 Volts DC, 2 batteries, lighting to German road vehicle regulations.

Crane superstructure

Frame	Self-manufactured, torsion resistant, welded construction of high-tensile steel. Connected to chassis by a 3-row roller slewing ring, 360° slewing range.
Engine	Diesel, 6 cylinder, watercooled, make Liebherr, type D 9406 TI-E, output 300 kW DIN (408 HP) at 1900 min ⁻¹ , max. torque 1710 Nm at 1400 min ⁻¹ .
Crane drive	Hydraulically by pump transfer case and 5 axial piston variable displacement pumps with capacity control, closed hydraulic circuits.
Crane control	Servo control with electronic synchronizing device on hoisting winches. Energy recycling during lowering of load. All motions controlled independently by joystick selectors.
Winches	Winches, hydraulically controlled by axial piston variable displacement pumps and planetary gears. Spring-loaded multi-disc brakes with hydraulic release.
Slewing gears	Hydraulically controlled by axial piston pump and planetary gear, spring-loaded multi-disc brake with hydraulic release. Infinitely variable slewing speed 0 – 1.2 min ⁻¹ .
Counterweight	160 t, consisting of: 1 base slab of 16 t, 12 slabs of 10 t each and 4 slabs of 6 t each. Additional counterweight 40 t option.
Operator's cab	Sheet steel design with safety glazing, movable sideward and inclinable to the rear, including operating equipment and check instruments.
Safety devices	LICCON safe load indicator, hoist limit switch, safety valves to protect hydraulic system against pipe and hose fracture.
Electrical system	24 V DC – 2 batteries, 143 Ah each.

Boom configurations

Design	SL – SLD – SD – SW – SWN – SDW – SDWN.
Optional features	Suspended ballast of 250 t for SLDB – SDB – SDWB.

Technische Beschreibung

Technical description

Description technique

Châssis porteur

Châssis	De fabrication Liebherr, construction en caisson souple à la torsion, réalisée en acier à grain très fin, de haute résistance.
Stabilisateurs	Quatre poutres déployables hydrauliquement avec vérins d'appui hydrauliques et semelles.
Moteur	Diesel, 8 cylindres, marque Liebherr, type D 9408 TI-E A5, refroidissement par eau, puissance 440 kW DIN (598 ch) à 2100 min ⁻¹ selon ECE-R 24.03 et 2001/27/EG (Euro 3), couple maxi. 2580 Nm à 1200 min ⁻¹ – 1500 min ⁻¹ . Capacité du réservoir carburant: 600 l.
Boîte	Boîte automatique, marque Allison, type CLBT 755, avec convertisseur de couple et ralentisseur hydraulique. 5 rapports AV et 1 AR. Boîte de transfert avec répartiteur différentiel avec blocage différentiel, rapport tout terrain.
Essieux	Essieux spéciaux lourds. Tous les 8 essieux disposent d'une suspension intégrale. Les essieux 1 à 4 et 7 et 8 sont directeurs. Les essieux 1, 2, 5 et 6 sont à trains planétaires avec blocage des différentiels.
Suspension	Tous les essieux disposent d'une suspension hydropneumatique avec système d'équilibrage automatique. Dispositif de répartition des charges entre tous les tandems d'essieux. Suspension blocable hydrauliquement.
Pneumatiques	24 pneumatique. Essieux 1, 2, 5 et 6 munis de roues simples, essieux 3, 4, 7 et 8 munis de roues doubles. Dimensions des pneumatiques: 14.00 R 25.
Direction	ZF assistée hydrauliquement, avec pompe auxiliaire entraînée par essieu, système à 2 circuits.
Freins	Servofrein à air comprimé agissant sur toutes les roues: système à 2 circuits. Frein à main: par cylindres à ressort agissant sur les essieux 2 à 7.
Cabine	Cabine spacieuse entièrement réalisée en tôles d'acier, suspension assurée par silentblochs, vitrage de sécurité, tableau de bord complet.
Installation électrique	24 Volts continus, 2 batteries, éclairage conforme au code.

Partie tournante

Châssis	Fabrication Liebherr, construction soudée en acier à résistance élevée. Liaison au châssis à chenilles par couronne d'orientation à 3 rangées de rouleaux. Orientation de 360°.
Moteur	Diesel, 6 cylindres, marque Liebherr, type D 9406 TI-E, refroidissement par eau, puissance 300 kW DIN (408 ch) à 1900 min ⁻¹ , couple maxi. 1710 Nm à 1400 min ⁻¹ .
Entraînement	Hydraulique par boîte transfert de pompe et 5 pompes à pistons axiaux à débit variable, asservissement de capacité, circuits hydrauliques fermés.
Commande de grue	Servocommande, dispositif de synchronisation. Recyclage d'énergie en abaissant une charge. Tous les mouvements de travaux sont exécutés individuellement moyennant de combinateurs, type manche à balai.
Treuil	Treuil, entraînement hydraulique par pompes à pistons axiaux à débit variable et engrenages planétaires. Freins à disques multiples commandés par ressort et à desserrage hydraulique.
Mécanismes	Entraînement hydraulique par pompe à pistons axiaux et engrenage planétaire, frein à disques multiples commandé par ressort et à desserrage hydraulique. Vitesse d'orientation à réglage continu 0 – 1,2 min ⁻¹ .
Contrepoids	160 t, comprenant: 1 plaque à 16 t et 12 plaques à 10 t et 4 plaques à 6 t. Contrepoids additionnel 40 t en option.
Cabine	En tôle d'acier, vitres de sécurité, orientable latéralement et inclinable en arrière. Organes de commande et de contrôle.
Sécurités	Contrôleur de charge LICCON, fin de course de levage, soupapes de sûreté, sur tubes et flexibles.
Système électrique	24 V continu, 2 batteries à 143 Ah.

Configurations de flèche

Conception lourde	SL – SLD – SD – SW – SWN – SDW – SDWN.
Équipement optionnel	Lest suspendu de 250 t pour SLDB – SDB – SDWB.

Maße Dimensions Encombrement

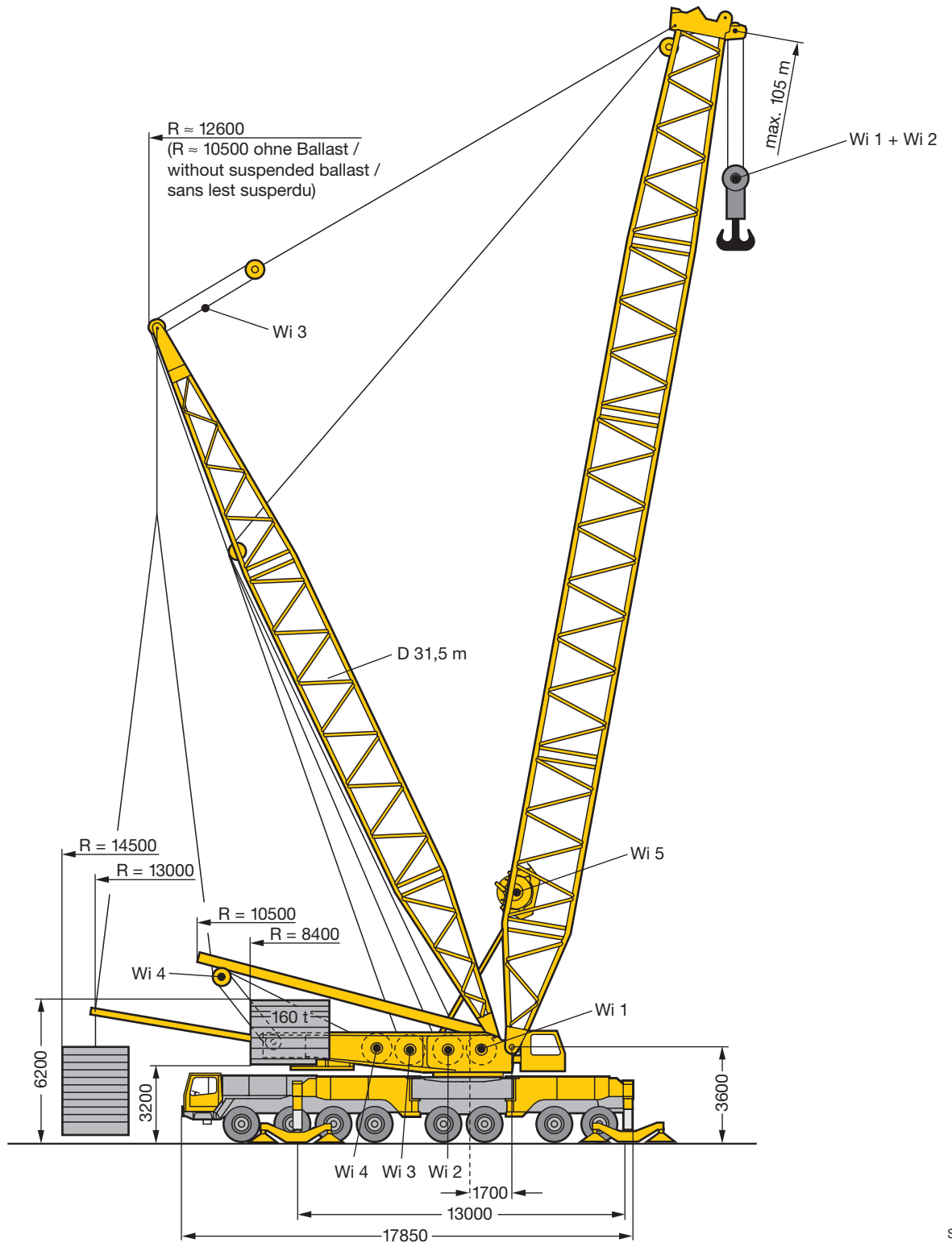

S2171

Maße Dimensions Encombrement

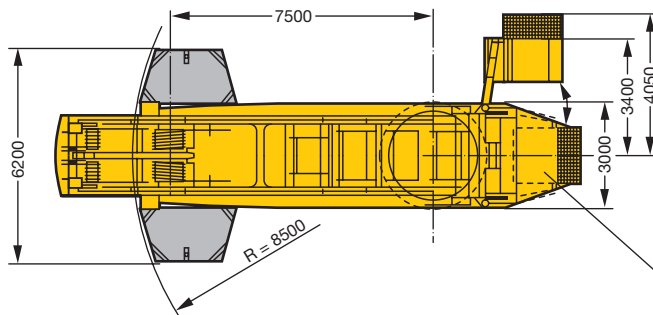
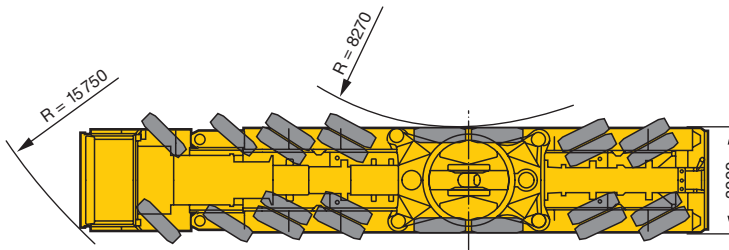
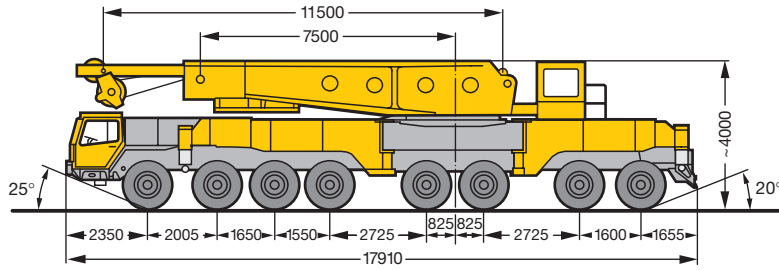

Kabine in Arbeitsstellung
Cabin in working position
Cabine en position de travail

Kabine in Fahrstellung
ohne Ausleger
Cabin in travelling
position without boom
Cabine en position de
transport sans flèche

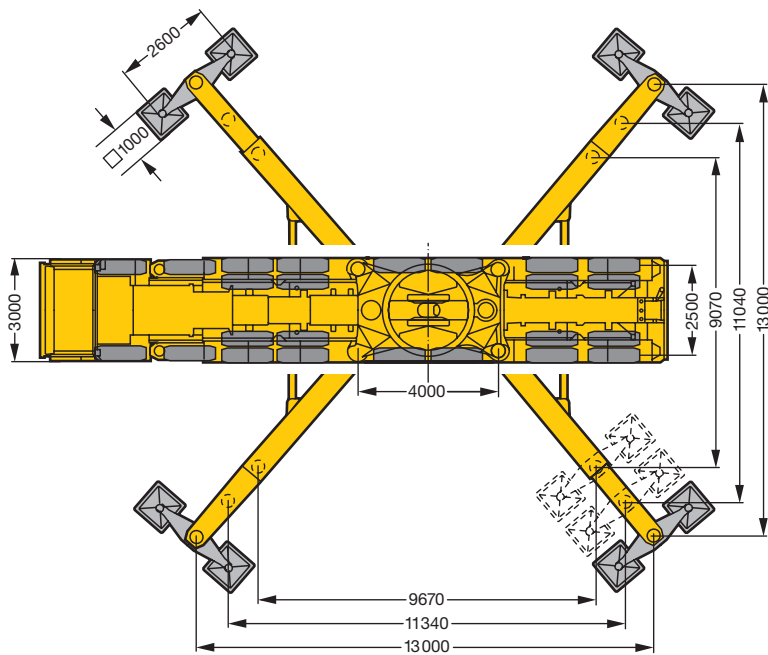

S1437

Gewichte Weights Poids









Achse Axle Essieu t	1	2	3	4	5	6	7	8	Gesamtgewicht t Total weight (metric tons) Poids total t
	12	12	12	12	12	12	12	12	96







Traglast t Load (metric tons) Forces de levage t	Rollen No. of sheaves Poulies	Stränge No. of lines Brins	Gewicht kg Weight kg Poids total kg
450 (225)	2 x 9 (9)	36 (18)	11000 (7000)
380 (190)	2 x 7 (7)	28 (14)	11000 (6500)
350	15	30	9000
235	9	18	6000
93	3	7	5000
41	1	3	2600
14,3	-	1	1100

Geschwindigkeiten Working speeds Vitesses



	1	2	3	4	5	R	 %
 km/h	14,7	20,6	32,6	48,6	67,5	15,5	18 %
 km/h 	7,6	11,4	18,1	26,4	37,4	8	34 %
	14.00 R 25						



Antriebe Drive Mécanismes	Zuordnung Mode Mode	Geschwindigkeiten Speeds Vitesses m/min	Max. Seilzug Max. single line pull Effort au brin maxi. kN	Seil ø Rope diameter Diamètre du câble mm	Seillänge Rope length Longueur du câble m
	Hubwerk 1 Hoist gear 1 Mécanisme de levage 1	0 – 140	140	28	1070
	Hubwerk 2, Synchronbetrieb mit Hubwerk 1 Hoist gear 2, synchronised with hoist gear 1 Mécanisme de levage 2, fonctionnement synchrone avec Mécanisme de levage 1	0 – 140	140	28	1070
	Verstellung Hauptausleger / D-Betrieb Derricking main boom / D-operation Relevation mât principale / en version D	0 – 140	140	28	1000
	Einziehwerk Derrick main boom Relevation mât principale	0 – 50	2 x 180	28	2 x 330
	Verstellung wippbare Gitterspitze Derricking luffing fly jib Relevation volée variable	0 – 140	140	28	1000

Transportplan Transportation plan Plan de transport

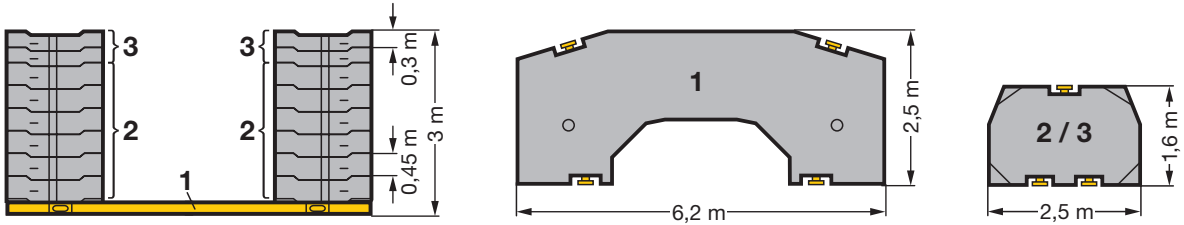
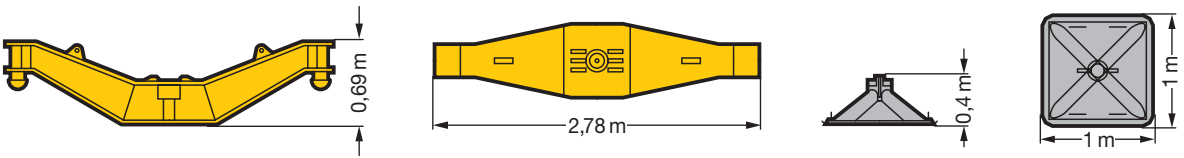
Baugruppen Components Ensembles		Gewicht t Weight t Poids t
Winde I mit Seil / Winch I with rope / Treuil I avec câble Winde II mit Seil / Winch II with rope / Treuil II avec câble Winde III mit Seil / Winch III with rope / Treuil III avec câble		4,8 4,8 5,5
Gegengewicht / Counterweight / Contrepoids Platte 1 / Slab 1 / Plaque 1 Platte 2 / Slab 2 / Plaque 2 Platte 3 / Slab 3 / Plaque 3 * Platte 2 / Slab 2 / Plaque 2	1 x 16 t 12 x 10 t 4 x 6 t 4 x 10 t	16 } 120 } 160 } 24 } 40 } 200
		
Traverse mit Abstützplatten / Travers with pad jacks / Travers avec semelles Traverse / Travers / Travers Abstützplatte / Pad jack / Semelle	4 x 0,8 t 8 x 0,1 t	3,2 0,8
		
* Zusatzgewichte / Additional ballast / Lest additionnel		

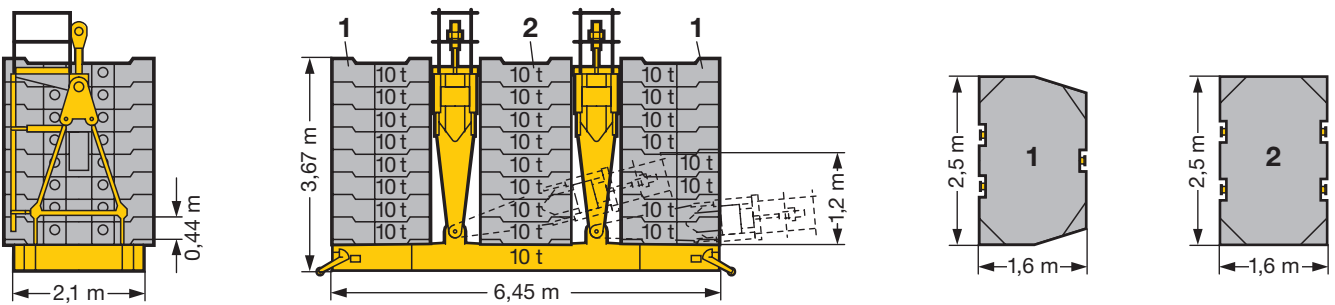
Zusatzrüstung Additional equipment Equipement optionnel		Abmessungen m Dimensions m Encombrement m	Gewicht t Weight t Poids t
Schwebeballast / Suspended ballast / Lest suspendu Ballastpalette mit Anhängereinrichtung Ballast pallet with suspension device Palette à lest avec dispositif de suspension	1 x 10 t	6,5 x 2,1 x 1,2	max. 250 10
Ballastplatte 1 / Ballast slap 1 / Plaque de lest 1 Ballastplatte 2 / Ballast slap 2 / Plaque de lest 2	16 x 10 t 8 x 10 t	2,5 x 1,6 x 0,4 2,5 x 1,6 x 0,4	160 80
			

Auslegersysteme

Boom/jib combinations

Configurations de flèche

S Hauptausleger, schwer
Main boom, heavy
Flèche principale, lourde

L Hauptausleger, leicht
Main boom, light
Flèche principale, légère

N Nadelausleger, leicht
Luffing jib, light
Flèchette, légère

W Wippausleger, schwer
Luffing jib, heavy
Flèchette, lourde

D Derrickausleger
Derrick
Flèche derrick

B Schwebeballast
Suspended ballast
Lest suspendu

H Mastnase
Rooster sheave
Poulies brin simple

K Knickausleger
Articulated main boom
Flèche à montage articulé

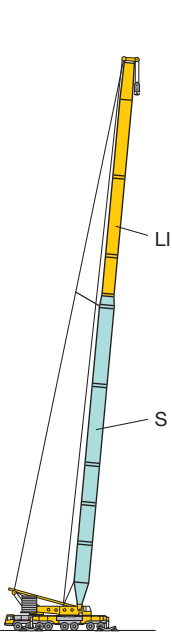

SL 21 m – 98 m

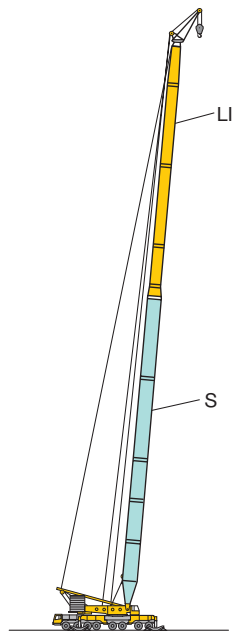

SL3H 63 m – 98 m

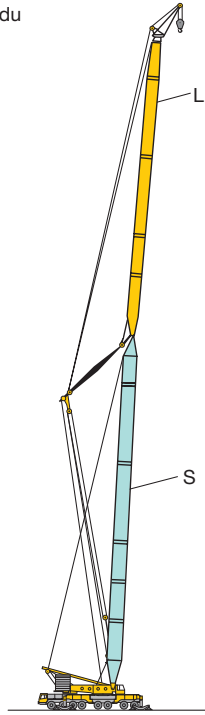

SLK 49 m – 63 m /
38,5 m – 52,5 m

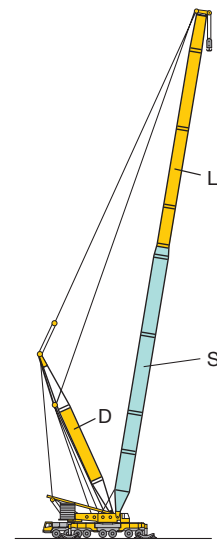

SLD 35 m – 91 m

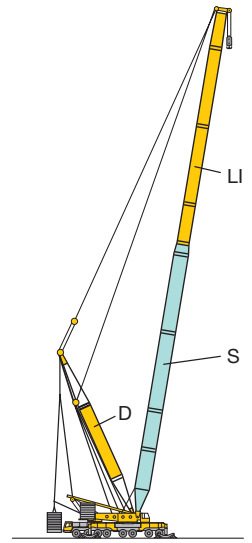

SLDB 35 m – 91 m

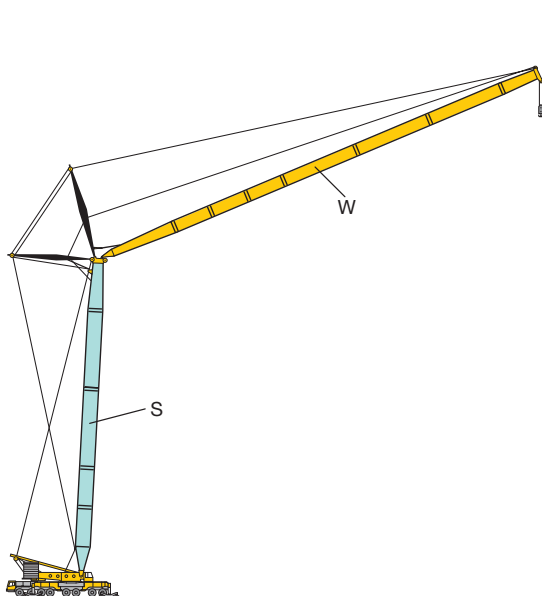

SW 28 m – 56 m / 28 m – 84 m

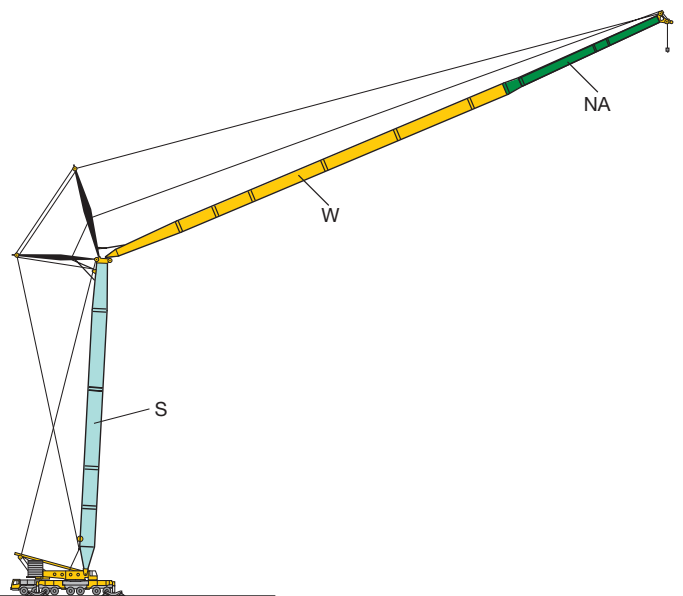

SWN 28 m – 49 m / 105 m

Auslegersysteme
Boom/jib combinations
Configurations de flèche

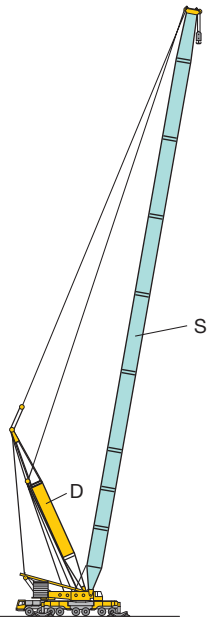

SD 35 m – 105 m

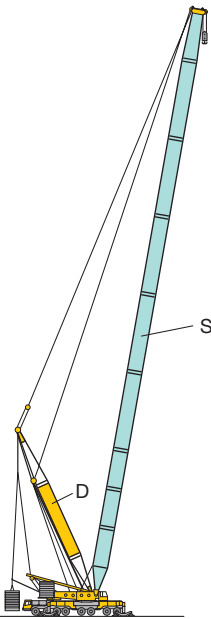

SDB 35 m – 105 m

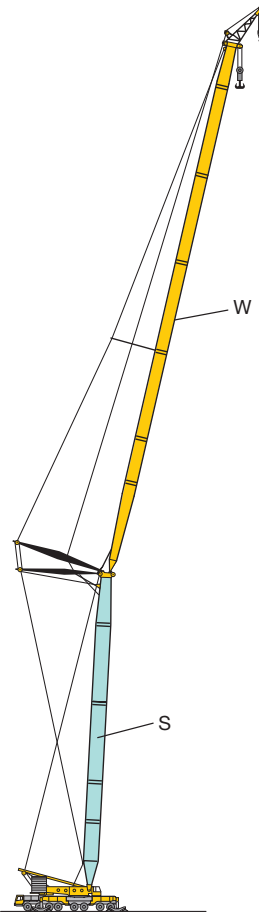

SWH 49,5 m – 56 m /
49 m – 84 m

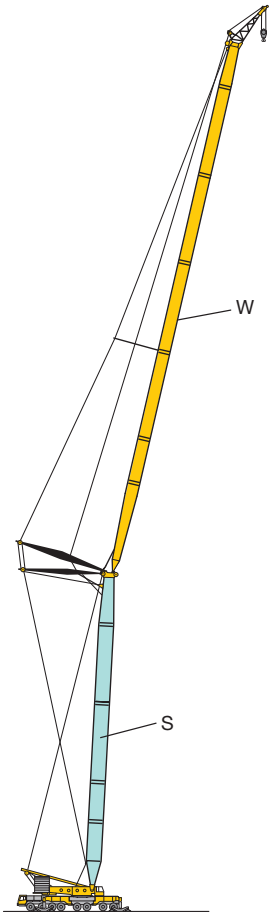

SW3H 49 m – 56 m /
49 m – 84 m

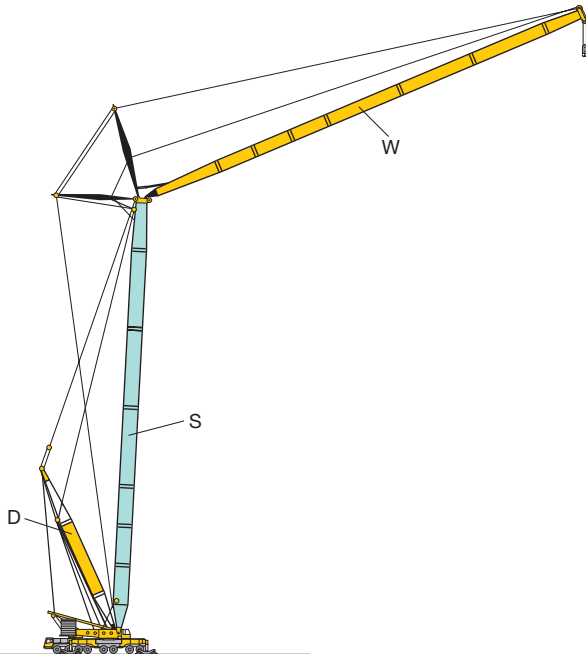

SDW 35 m – 77 m / 28 m – 84 m

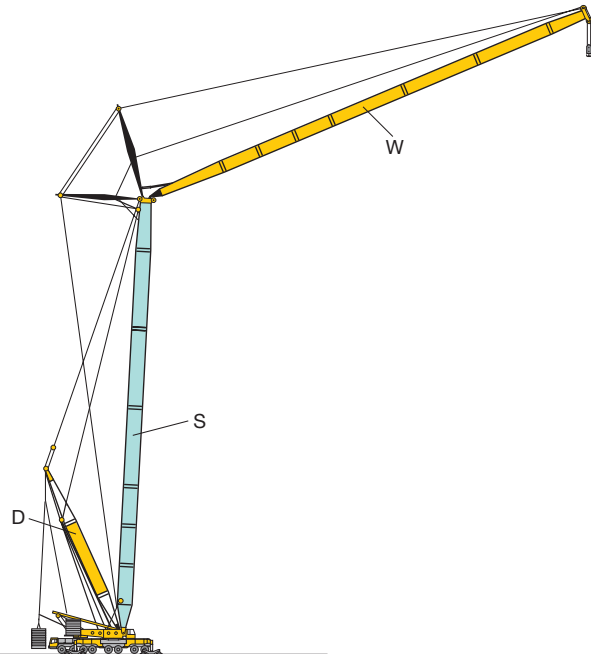

SDWB 35 m – 77 m / 28 m – 84 m



S2175

Traglasten am SL-Ausleger

Lifting capacities on SL boom

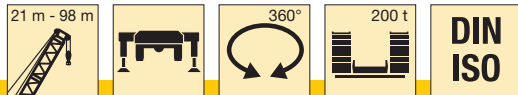
Forces de levage à la flèche principale SL



 m	21 m	28 m	35 m	42 m	49 m	56 m	63 m	70 m	77 m	84 m	91 m	98 m	 m
4,5	350												4,5
5	350												5
5,5	350	350											5,5
6	350	350	350										6
6,5	350	350	350										6,5
7	350	350	350	346									7
8	338	332	325	318	317								8
9	313	307	301	294	293	283	244						9
10	291	285	280	274	273	269	242	222	190				10
11	265	260	255	249	248	245	240	217	189	157	140		11
12	242	238	233	228	227	225	221	211	187	155	138	120	12
14	201	204	200	195	194	192	189	187	182	152	135	119	14
16	172	177	174	169	168	166	164	162	160	148	132	118	16
18	151	157	153	149	148	146	144	142	140	138	128	117	18
20	133	140	137	133	132	130	128	126	124	122	121	116	20
22		126	123	119	118	117	115	113	111	109	108	105	22
24		114	112	108	107	106	104	101	100	98	97	94	24
26		104	102	98	97	96	94	92	90	88	87	85	26
28			94	90	89	88	86	84	82	80	79	76	28
30			86	83	82	81	79	77	75	73	72	69	30
32			78	77	76	74	73	70	69	67	66	63	32
34				71	70	69	67	65	63	62	60	58	34
36				66	65	64	62	60	58	57	55	53	36
38				60	61	59	58	55	54	52	51	48	38
40					57	55	54	51	50	48,5	46,5	44	40
44					48	48,5	47	44,5	43	41,5	39,5	37	44
48						43	41,5	38,5	37,5	35,5	34	31,5	48
52							36,5	33,5	32,5	31	28,8	26,4	52
56							31	29,6	28,2	26,7	24,5	22,1	56
60								25,8	24,6	23,1	20,8	18,3	60
64										21,5	19,9	17,5	64
68										17,8	17	14,6	68
72											14,6	12	72
76												9,6	76
80												7,3	80
84												3,5	84

Traglasten über 350 t nur mit Zusatzeinrichtung nach hinten (Spezialauslegerkopf und andere Abstützung)
 Lifting capacities above 350 t only with special equipment over rear (special boomhead and another support base)
 Forces de levage plus de 350 t seulement avec équipement spécial en arrière (tête de flèche spéciale et une autre base d'appui)

TAB 49281

Traglasten am SL-Ausleger

Lifting capacities on SL boom

Forces de levage à la flèche principale SL

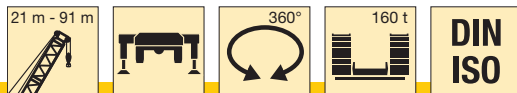

	21 m)	21 m	28 m	35 m	42 m	49 m	56 m	63 m	70 m	77 m	84 m	91 m	
4,5	550	350											4,5
5	500	350											5
5,5	460	350	350										5,5
6	420	350	350	350									6
6,5	390	350	350	350									6,5
7	361	350	350	347	340								7
8	332	332	325	319	312	311							8
9	299	299	292	286	280	280	276	244					9
10	269	269	264	258	252	252	248	242	222	190			10
11	245	245	240	235	230	229	226	222	217	189	157	140	11
12	225	225	220	215	210	210	207	204	202	187	155	138	12
14	192	192	188	184	179	178	176	173	172	169	152	135	14
16	167	167	163	160	156	155	153	150	148	146	144	132	16
18	147	147	144	141	137	136	134	132	130	128	126	125	18
20	130	130	129	125	122	121	119	117	115	113	111	110	20
22			115	113	109	108	107	105	102	101	99	98	22
24			104	102	99	98	96	94	92	90	89	87	24
26			94	93	90	89	87	86	83	82	80	78	26
28				85	82	81	80	78	76	74	72	71	28
30				78	75	74	73	71	69	67	66	64	30
32				71	69	68	67	66	63	62	60	58	32
34					63	63	62	61	58	57	55	53	34
36					58	58	57	56	53	52	50	48,5	36
38					53	53	53	52	49,5	48	46,5	44,5	38
40						48,5	48,5	48	45,5	44	42,5	41	40
44						41,5	41,5	41	39	38	36	34,5	44
48							35,5	35	33	32	30,5	28,8	48
52								30,5	28,4	27,2	25,7	23,8	52
56								26,6	24,4	23,1	21,6	19,6	56
60									21	19,6	18,1	16	60
64										16,6	15	12,7	64
68										13,9	12,3	9,7	68
72											9,9	7,1	72
76												5,4	76
80												4	80

*) mit Zusatzeinrichtung / with special equipment / avec équipement spécial
 Traglasten über 350 t nur mit Zusatzeinrichtung nach hinten (Spezialauslegerkopf und andere Abstützung)
 Lifting capacities above 350 t only with special equipment over rear (special boomhead and another support base)
 Forces de levage plus de 350 t seulement avec équipement spécial en arrière (tête de flèche spéciale et une autre base d'appui)

Hubhöhen am SL-Ausleger
Lifting heights on SL boom
Hauteurs de levage à la flèche principale SL

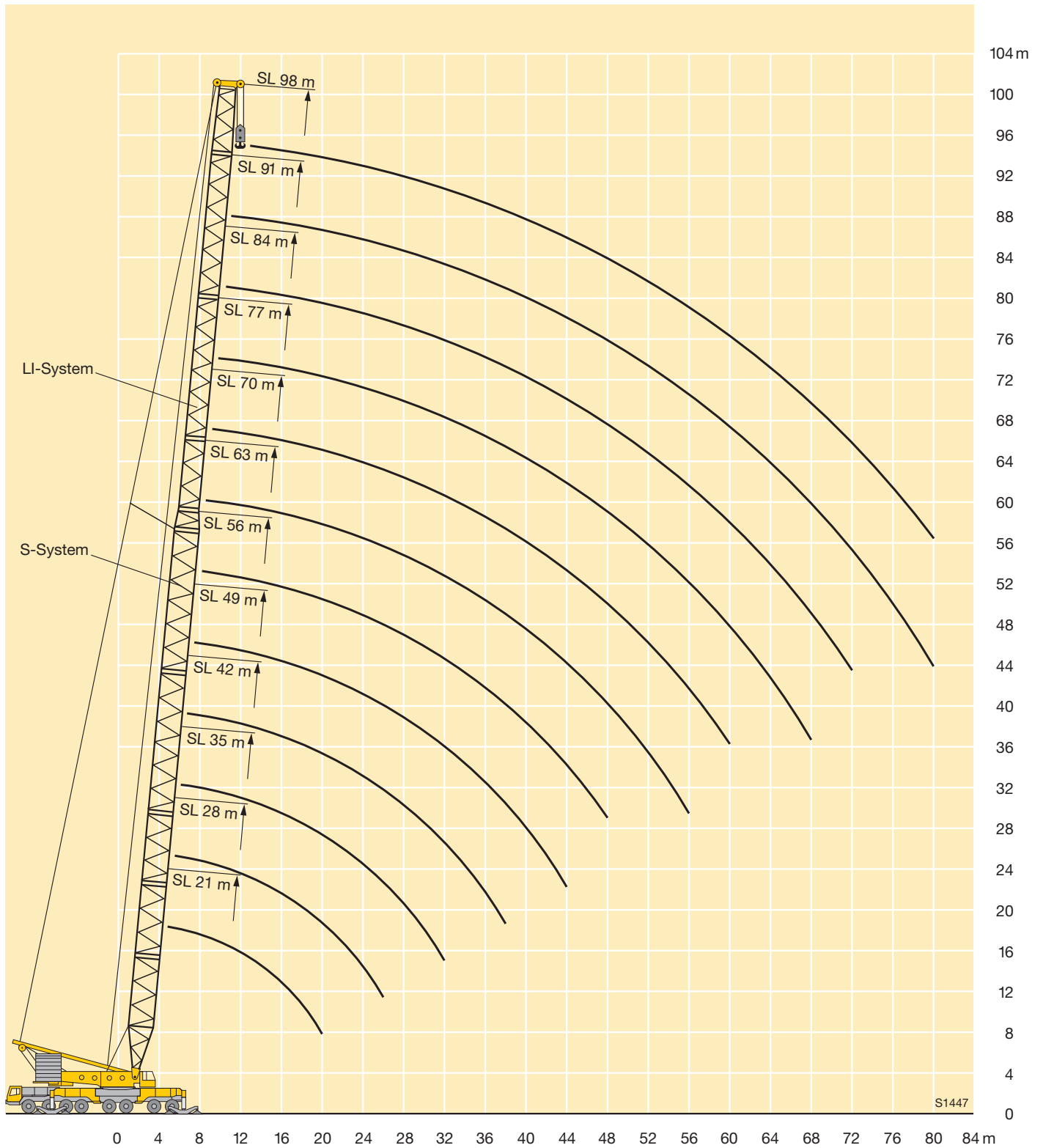

Traglasten am SL3H-Ausleger

Lifting capacities on SL3H boom

Forces de levage à la flèche principale SL3H



m	63 m	70 m	77 m	84 m	91 m	98 m	m
	6 m	6 m	6 m	6 m	6 m	6 m	
11	100	100					11
12	100	100	100	100	100		12
14	100	100	100	100	100	94	14
16	100	100	100	100	100	94	16
18	97	99	100	100	97	92	18
20	95	96	98	99	94	90	20
22	92	94	96	97	92	88	22
24	90	92	94	95	89	86	24
26	87	90	91	92	87	85	26
28	84	87	85	83	82	79	28
30	81	80	78	76	75	72	30
32	75	73	72	70	68	66	32
34	70	68	66	64	62	60	34
36	65	63	61	59	57	55	36
38	60	58	57	55	53	50	38
40	56	54	52	51	49	46,5	40
44	49	47	45,5	43,5	41,5	39,5	44
48	43,5	41	39,5	38	36	33,5	48
52	38,5	36	34,5	33	30,5	28,4	52
56	34	32	30,5	28,7	26,4	24,1	56
60	30,5	28,3	26,6	25	22,7	20,4	60
64		25	23,4	21,8	19,5	17,1	64
68		22,2	20,5	19	16,6	14,2	68
72			18,1	16,5	14,1	11,7	72
76				14,3	11,8	9,4	76
80				12,3	9,8	7,3	80
84					8,1	5,9	84

TAB 49287

Hubhöhen am SL3H-Ausleger
Lifting heights on SL3H boom
Hauteurs de levage à la flèche principale SL3H

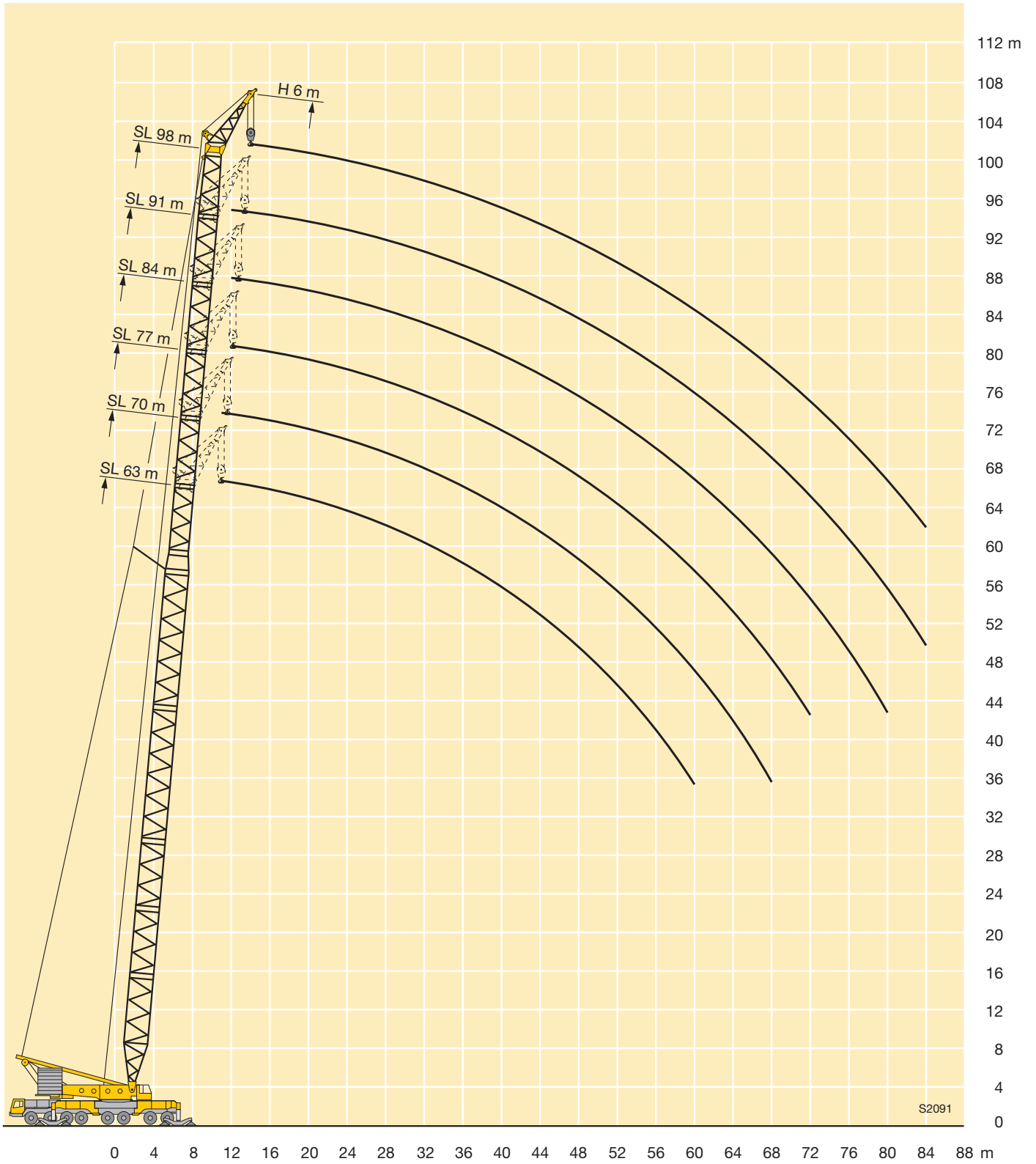

Traglasten am SLK-Auslegersystem

Lifting capacities on SLK boom/jib combination

Forces de levage en configuration SLK

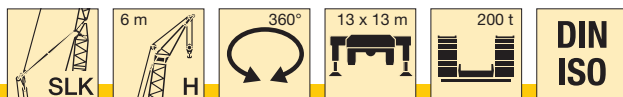

m	49 m		56 m		56 m		63 m		63 m		m
	38,5 m		38,5 m		45,5 m		45,5 m		52,5 m		
	6 m		6 m		6 m		6 m		6 m		
20	90	100	93	86	90	82	86	20			
22	82	90	86	80	84	76	82	22			
24	75	84	80	78	78	71	76	24			
26	69	78	75	72	72	66	71	26			
28	64	73	70	65	65	61	66	28			
30	59	68	65	59	59	57	61	30			
32	55	63	61	53	53	52	57	32			
34	52	58	56	48	48	46,5	52	34			
36	49	53	51	43,5	43,5	42	46,5	36			
38	46	48	46,5	39,5	39,5	38	42	38			
40	43,5	44	42,5	32,5	32,5	31	38	40			
44	38	37	35,5	26,4	26,4	25	31	44			
48	34	31	29,5	21,4	21,4	20	25	48			
52	28,8	25,8	24,4	17,1	17,1	15,7	20	52			
56	24,4	21,4	20,1	13,4	13,4	12	15,7	56			
60	20,6	17,7	16,3	10,1	10,1	8,8	12	60			
64	17,3	14,4	13,1	7	7	6	8,8	64			
68	14,4	11,5	10,2	5,1	5,1	4,1	6	68			
72	11,9	8,9	7,6	3,3	3,3		4,1	72			
76	9,6	6,6	5,6					76			
80	7,5	5	4					80			
84		3,6						84			

TAB 49303

Hubhöhen am SLK-Auslegersystem
Lifting heights on SLK boom/jib combination
Hauteurs de levage en configuration SLK

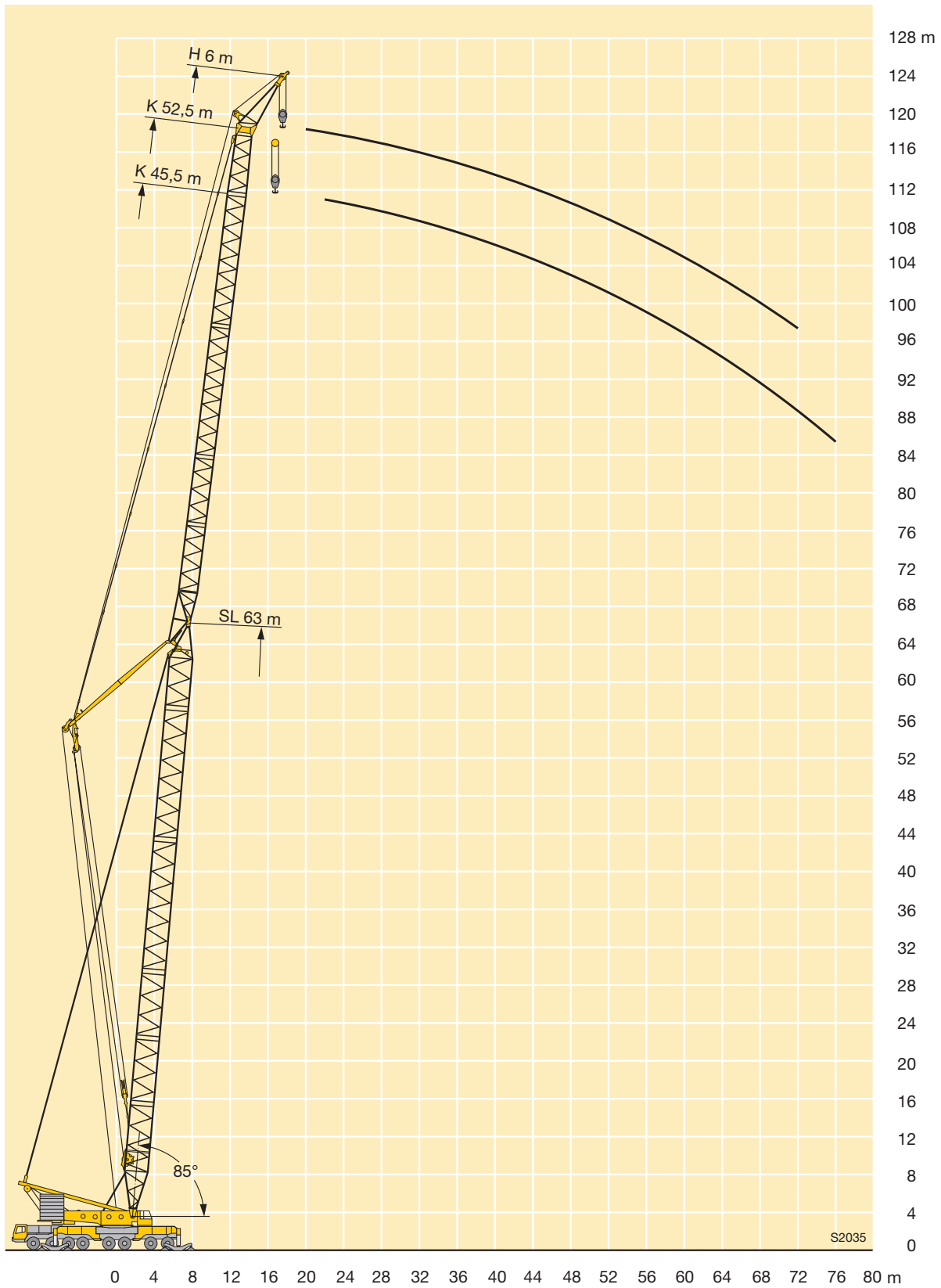

Traglasten am SLD-Auslegersystem

Lifting capacities on SLD boom/derrick combination

Forces de levage en configuration SLD

m	35 m - 91 m		31,5 m	360°	200 t	DIN ISO					m
	35 m	42 m					49 m	56 m	63 m	70 m	
9	300										9
10	277	272									10
11	252	249									11
12	230	228		227	227						12
14	197	194		193	193	191					14
16	171	169		168	167	166	165	162			16
18	151	148		148	148	145	144	142	140	136	18
20	135	132		131	131	129	128	125	124	123	20
22	121	118		118	117	116	114	112	110	110	22
24	109	107		106	105	104	102	101	99	98	24
26	99	97		96	95	95	93	91	90	88	26
28	91	88		87	87	86	84	82	81	80	28
30	84	81		80	80	79	77	75	74	72	30
32	77	75		74	73	73	71	69	68	66	32
34		69		68	68	67	65	63	62	60	34
36		65		63	63	62	60	58	57	55	36
38		60		59	59	58	55	54	53	51	38
40				55	55	54	51	49,5	48,5	46,5	40
44				49	48	46,5	44	42,5	41,5	39,5	44
48					42,5	41	38,5	37	35,5	33,5	48
52						36	33,5	32	30,5	28,6	52
56						32,5	29,4	27,7	26,5	24,2	56
60							25,9	24,1	22,8	20,5	60
64								21	19,7	17,2	64
68								18,4	16,9	14,3	68
72									14,5	10	72

TAB 49070

m	35 m - 91 m		31,5 m	360°	160 t	DIN ISO					m
	35 m	42 m					49 m	56 m	63 m	70 m	
9	288										9
10	259	256									10
11	236	233									11
12	216	213		212	210						12
14	184	181		181	178	176					14
16	160	157		156	154	152	151	148			16
18	139	137		136	135	133	132	130	128	127	18
20	123	121		120	120	118	116	114	113	112	20
22	110	108		107	107	106	104	102	100	99	22
24	99	97		96	96	95	93	91	90	89	24
26	90	88		87	87	86	84	82	81	80	26
28	83	80		79	79	78	76	74	73	72	28
30	76	73		72	72	71	69	68	66	65	30
32	70	68		67	66	66	63	62	61	59	32
34		63		62	61	60	58	57	55	54	34
36		58		57	57	56	54	52	51	49	36
38		54		53	53	52	49,5	47,5	46,5	44,5	38
40				49,5	49	48	45,5	44	43	41	40
44				43,5	43	41,5	39	37,5	36	34	44
48					38	36	33,5	32	31	28,7	48
52						32	29,1	27,4	26,2	24	52
56						28	25,2	23,5	22,2	19,9	56
60							21,9	20,1	18,8	16,4	60
64								17,1	15,7	13,3	64
68								14,5	13	10,3	68
72									10,6	7,5	72

TAB 49071

Hubhöhen am SLD-Auslegersystem

Lifting heights on SLD boom/derrick combination

Hauteurs de levage en configuration SLD

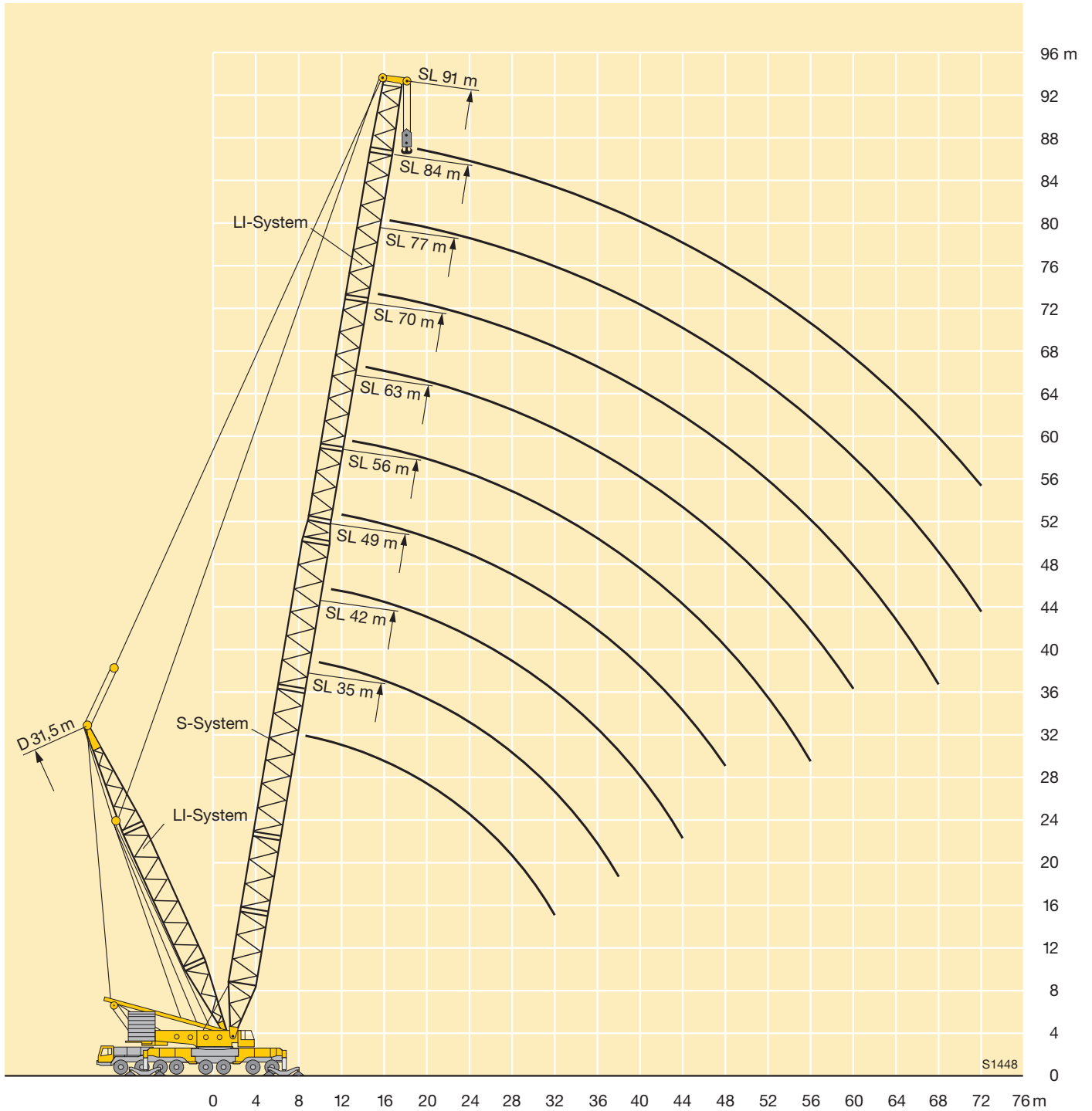

Traglasten am SLDB-Auslegersystem

Lifting capacities on SLDB boom/derrick combination

Forces de levage en configuration SLDB

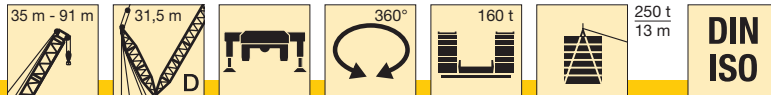

	35 m	42 m	49 m	56 m	63 m	70 m	77 m	84 m	91 m	
9	410									9
10	390	350								10
11	370	345								11
12	350	340	320	277						12
14	337	326	318	274	229					14
16	313	303	294	272	225	214	195			16
18	287	282	274	268	220	208	192	167	136	18
20	253	251	250	249	216	202	189	160	131	20
22	226	224	223	222	212	196	182	154	126	22
24	212	202	201	200	199	190	175	148	120	24
26	195	190	182	181	180	179	167	141	115	26
28	178	176	171	167	164	163	160	135	110	28
30	164	162	161	158	155	149	148	128	104	30
32	152	150	149	148	147	141	138	122	99	32
34		139	138	137	136	134	130	116	94	34
36		129	128	127	126	125	124	109	88	36
38		121	120	120	119	118	117	103	83	38
40			113	112	111	110	109	98	78	40
44			100	99	98	97	96	88	67	44
48				89	88	86	85	80	60	48
52					79	77	76	72	53	52
56					71	69	68	63	46	56
60						62	61	55	39	60
64							56	46	29	64
68							51	36	20	68
72								27	10	72

Traglasten über 350 t nur mit Zusatzeinrichtung
 Lifting capacities above 350 t only with special equipment
 Forces de levage plus de 350 t seulement avec équipement spécial

TAB 49166 / 49110



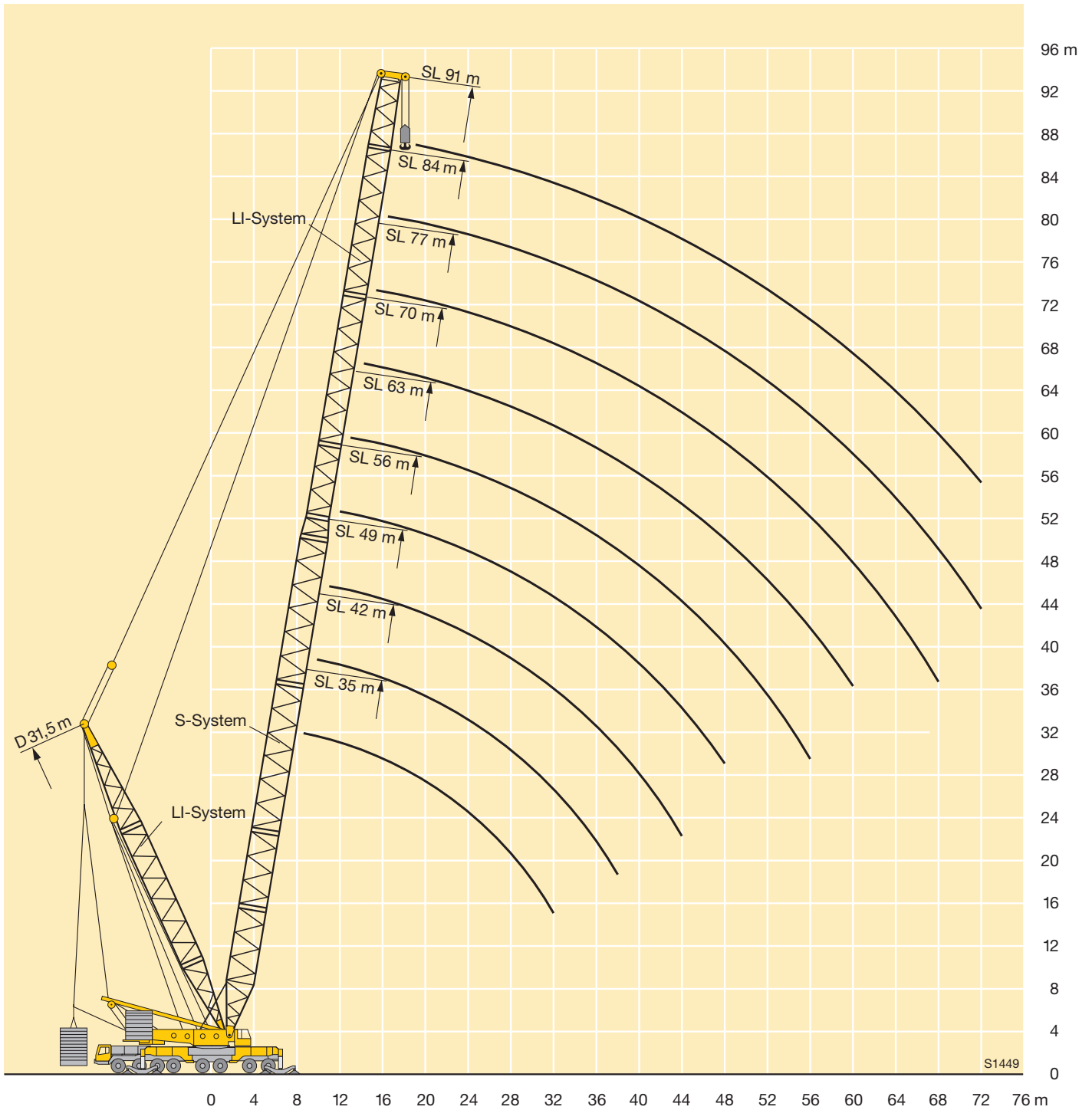















Hubhöhen am SLDB-Auslegersystem
Lifting heights on SLDB boom/derrick combination
Hauteurs de levage en configuration SLDB



Traglasten am SD-Auslegersystem

Lifting capacities on SD boom/derrick combination

Forces de levage en configuration SD

	 35 m - 105 m	 31,5 m		 360°	 200 t	 DIN ISO								
	 35 m	 42 m	 49 m	 56 m	 63 m	 70 m	 77 m	 84 m	 91 m	 98 m	 105 m	 112 m	 119 m	
9	295												9	
10	273	268											10	
11	248	246											11	
12	227	225	223	220									12	
14	193	191	189	186	181								14	
16	167	165	163	160	156	154	150						16	
18	147	145	143	140	135	133	130	126	125				18	
20	131	129	127	123	119	117	113	110	108	105	102		20	
22	117	115	113	110	106	103	100	96	95	92	88		22	
24	106	103	102	98	94	92	89	85	83	80	77		24	
26	96	94	92	89	85	82	79	76	74	71	68		26	
28	87	85	83	80	76	74	71	67	65	63	59		28	
30	80	78	76	73	69	66	64	60	58	55	52		30	
32	74	72	70	67	63	60	57	54	52	49	46		32	
34		66	64	61	57	54	52	48,5	46	43	40		34	
36		61	59	56	52	49,5	46,5	43,5	41	38	35		36	
38		57	55	52	48	45	42	39	36	33,5	30,5		38	
40			51	47,5	44	41	38	34,5	32	29,4	26,3		40	
44			44,5	41	37	34	31	27,7	24,8	22,1	18,8		44	
48				35	31,5	28,1	25	21,7	18,7	15,7	11,9		48	
52					26,6	23,2	20,1	16,6	13,3	9,5	5,5		52	
56					22,8	19,1	15,8	12	7,6				56	
60						15,6	12	7,4					60	
64							8,5						64	
68							6						68	

TAB 49160



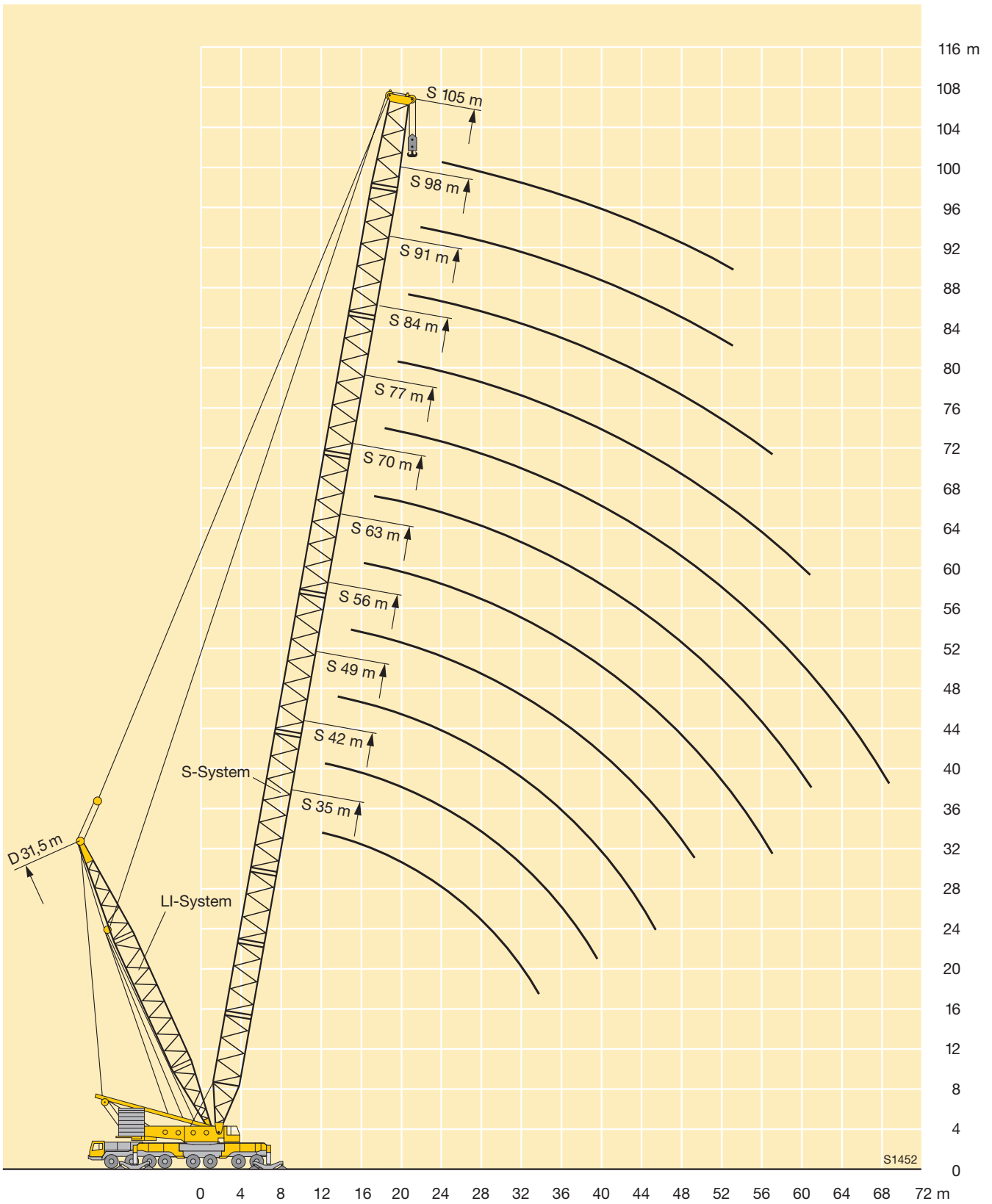





Hubhöhen am SD-Auslegersystem Lifting heights on SD boom/derrick combination Hauteurs de levage en configuration SD



Traglasten am SDB-Auslegersystem

Lifting capacities on SDB boom/derrick combination

Forces de levage en configuration SDB

	 35 m - 105 m	 31,5 m		 360°	 160 t	 250 t	 DIN ISO	35 m	42 m	49 m	56 m	63 m	70 m	77 m	84 m	91 m	98 m	105 m	
9	370																		9
10	350	335																	10
11	332	318																	11
12	318	305		278															12
14	293	280	263	255	244														14
16	271	259	242	235	224	217	210												16
18	252	241	225	218	208	201	195	190	165										18
20	236	224	209	202	193	186	180	177	162	140	120								20
22	221	210	196	189	180	173	168	165	159	137	117								22
24	208	197	184	177	168	162	156	153	150	134	115								24
26	190	186	173	166	158	152	146	143	140	132	112								26
28	174	172	163	157	148	142	137	134	131	127	110								28
30	160	157	154	148	140	134	129	126	122	119	107								30
32	146	145	144	140	132	126	121	118	115	112	105								32
34		134	133	132	125	119	114	111	108	105	102								34
36		125	124	123	118	113	108	105	102	99	96								36
38		117	116	115	112	107	102	99	96	93	90								38
40			112	110	107	101	97	94	90	87	85								40
44			99	97	96	92	87	84	81	78	75								44
48				86	85	83	79	76	72	70	67								48
52					78	75	71	68	65	62	60								52
56					70	67	64	62	59	56	53								56
60						60	57	55	52	50	48								60
64							51	48	46	44	42								64
68								45	43	40	38								68
72									38	35	33								72
76										31	29								76
80											27								80
84																	21	19	84
88																		16	88
92																		13	92

TAB 49152

Hubhöhen am SDB-Auslegersystem
Lifting heights on SDB boom/derrick combination
Hauteurs de levage en configuration SDB

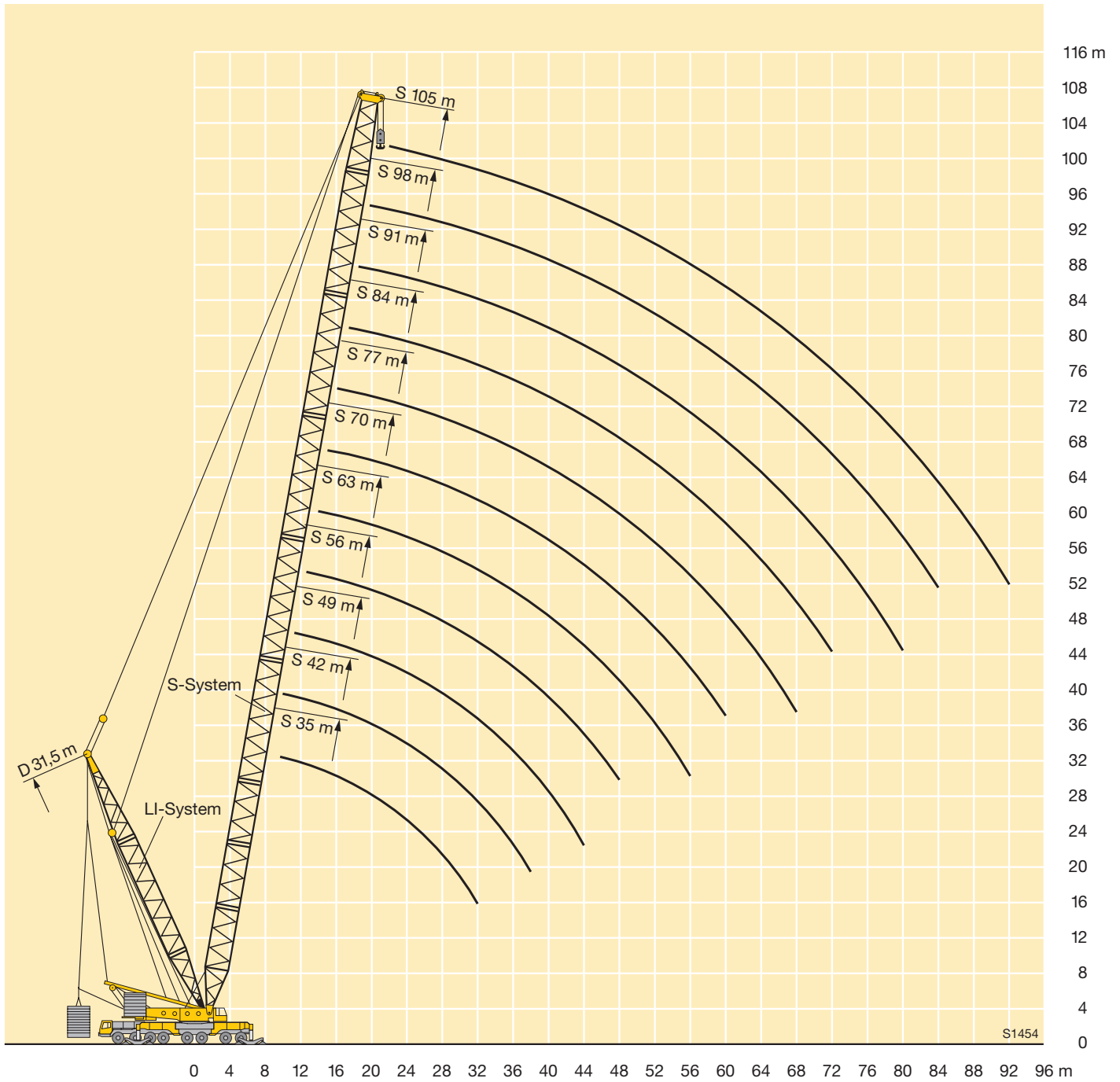

Traglasten am SW-Auslegersystem

Lifting capacities on SW boom/jib combination

Forces de levage en configuration SW

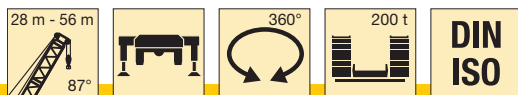

m	28 m								35 m								m		
	28 m	35 m	42 m	49 m	56 m	63 m	70 m	77 m	84 m	28 m	35 m	42 m	49 m	56 m	63 m	70 m		77 m	84 m
14	196									194									14
16	171	170								169	169								16
18	151	151	150	149						150	149	148							18
20	136	135	134	133						134	133	132	131	124					20
22	122	122	121	120	118	109				121	120	119	118	116	101				22
24	111	110	110	109	107	106	91			110	109	108	107	105	99	86			24
26	101	101	100	99	98	96	89	75		100	100	98	97	95	94	85	72		26
28	93	92	92	91	89	88	86	74	62	92	91	90	89	87	86	83	71	59	28
30	86	85	84	84	82	81	79	74	61	85	84	83	82	80	79	77	71	58	30
32		79	78	78	76	75	73	71	60		78	77	76	74	73	71	69	57	32
34		73	73	72	71	69	68	66	59		72	72	70	69	67	66	64	56	34
36		69	68	67	66	64	63	61	58		68	67	66	64	63	61	59	55	36
38			63	63	61	60	58	57	55			62	61	60	58	57	55	53	38
40			59	59	57	56	54	53	51			59	57	56	54	53	51	49	40
44				52	50	49	47,5	46	44			52	51	49	47,5	46	44	42,5	44
48				46,5	45	43,5	42	40	38,5				45	43,5	42	40,5	38,5	37	48
52					40	38,5	37	35,5	33,5					38,5	37,5	35,5	34	32	52
56					36	34,5	33	31	29,3					35	33	31,5	29,8	28	56
60						31	29,4	27,5	25,7						29,8	28,2	26,3	24,4	60
64							26,3	24,4	22,6						26,8	25,1	23,2	21,3	64
68							23,6	21,6	19,8							22,5	20,5	18,6	68
72								19,2	17,3								18,1	16,2	72
76								17,1	15,1								16,1	14	76
80									13,1									12	80
84																		10,2	84

TAB 49177

m	42 m								49 m								56 m					m				
	28 m	35 m	42 m	49 m	56 m	63 m	70 m	77 m	84 m	28 m	35 m	42 m	49 m	56 m	63 m	70 m	77 m	84 m	35 m	42 m	49 m		56 m	63 m		
14	193																								14	
16	168	167								166																16
18	148	148	145							147	145	142								142	134					18
20	133	132	130	128	117					131	129	127	125							127	124	113				20
22	120	119	117	115	113	96				118	116	114	113	106						114	112	110	94			22
24	108	108	106	104	102	94	81			107	106	104	102	100	87					104	101	99	92	79		24
26	99	98	96	95	93	91	80	68		98	97	94	93	91	85	74				95	92	91	89	77		26
28	91	90	88	87	85	84	79	67	57	90	89	87	85	83	82	72	62			87	85	83	81	76		28
30	84	83	81	80	78	77	75	67	56	83	82	80	78	77	75	71	61	52		80	78	76	75	72		30
32		77	75	74	72	71	69	66	55		76	74	72	71	69	67	60	51		74	72	70	69	67		32
34		72	70	69	67	66	64	62	54		70	69	66	66	64	62	60	51		69	67	65	64	62		34
36		67	65	64	62	61	59	57	53		66	64	62	61	59	58	56	50		64	63	61	59	57		36
38		63	61	60	58	57	55	53	51		62	60	58	57	55	53	52	49,5		60	58	57	55	53		38
40			57	56	54	53	51	49	47,5			56	55	53	51	49,5	48	46			55	53	51	49,5		40
44			51	49,5	47,5	46	44,5	42,5	41			49,5	48	46,5	45	43,5	41,5	39,5			48,5	46,5	45	43		44
48				44	42	40,5	39	37	35,5				42,5	41	39,5	38	36	34				41,5	40	38		48
52					37,5	36	34,5	32,5	30,5					36,5	35	33,5	31,5	29,6				37	35,5	33,5		52
56					34	32	30,5	28,5	26,6					32,5	31	29,4	27,5	25,6					31,5	29,5		56
60						28,6	27	25	23,2						27,6	26	24	22,2						26,2		60
64						25,7	24	22	20,1						24,7	23	21,1	19,2						23,4		64
68							21,4	19,4	17,4							20,5	18,5	16,4								68
72								17	14,9								16,1	14								72
76								15	12,7								14,1	11,8								76
80									10,7									9,7								80
84									9									7,7								84

TAB 49177

Hubhöhen am SW-Auslegersystem
Lifting heights on SW boom/jib combination
Hauteurs de levage en configuration SW

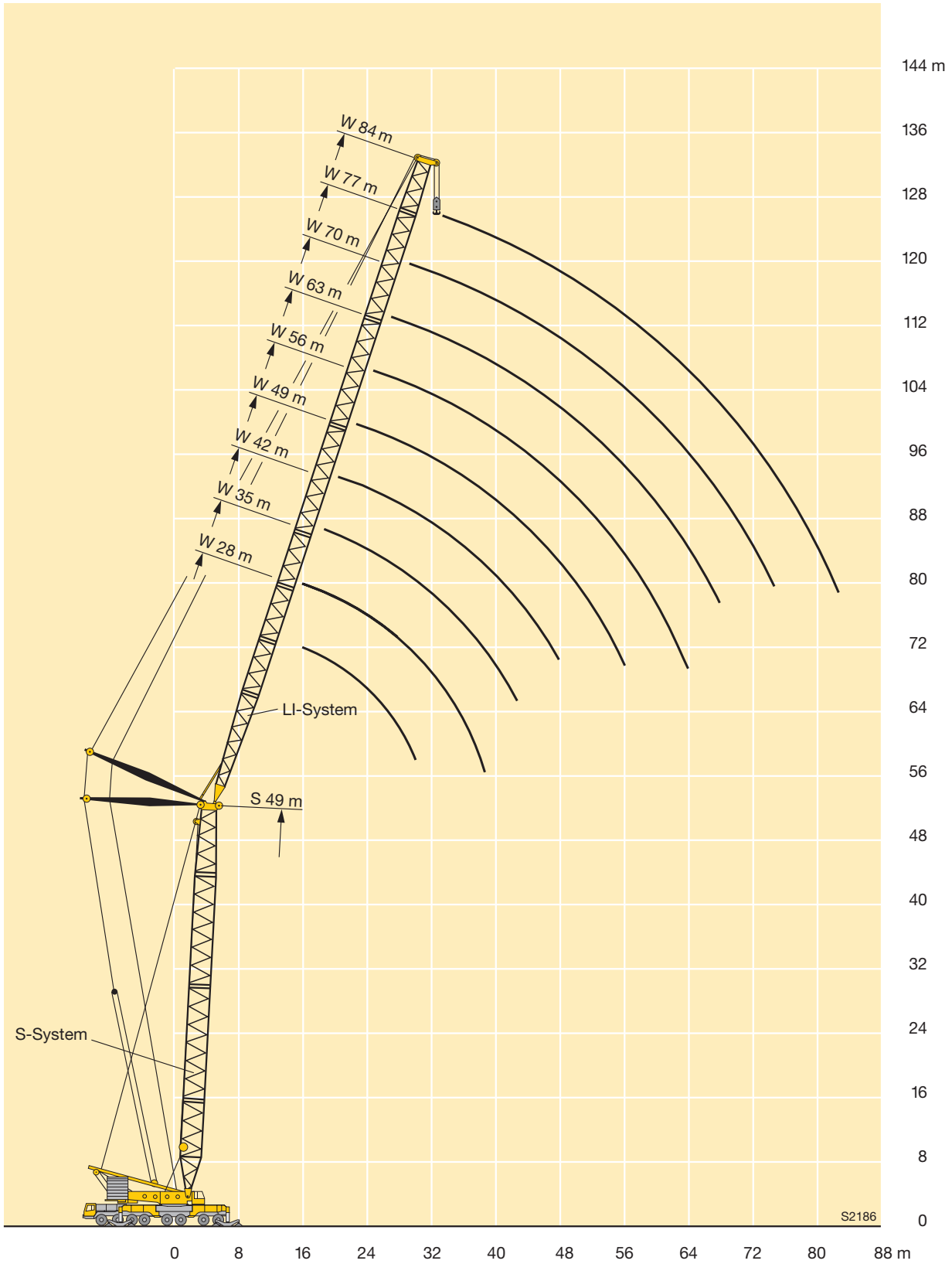

Traglasten am SWH-Auslegersystem

Lifting capacities on SWH boom/jib combination

Forces de levage en configuration SWH



m	49 m					56 m			m
	56 m	63 m	70 m	77 m	84 m	49 m	56 m	63 m	
23						95			23
24						95			24
26	87	81				87	84		26
28	80	77	69			79	77	74	28
30	73	70	68	55		73	71	68	30
32	67	65	63	54	47	67	65	62	32
34	62	60	58	53	46	62	60	57	34
36	57	55	53	51	45,5	58	55	53	36
38	53	51	49	47	44,5	53	51	49	38
40	49,5	47	45,5	43	41	50	47,5	45	40
44	43	40,5	39	37	35	43,5	41,5	39	44
48	37,5	35,5	33,5	31,5	29,7	38	36	33,5	48
52	33	31	29,1	27,2	25,3	33,5	31,5	29,3	52
56	29	26,8	25,2	23,3	21,4		27,7	25,4	56
60	25,6	23,4	21,8	20	18,1		24,3	22,1	60
64		20,4	18,9	17	15,2			19,2	64
68			16,2	14,5	12,7				68
72			13,9	12,2	10,4				72
76				10,1	8,3				76
80					6,6				80

Tragkräfte an der Mastnase / Lifting capacities on the rooster sheave / Forces de levage à la poulie brin simple

TAB 49294

Hubhöhen am SWH-Auslegersystem
Lifting heights on SWH boom/jib combination
Hauteurs de levage en configuration SWH

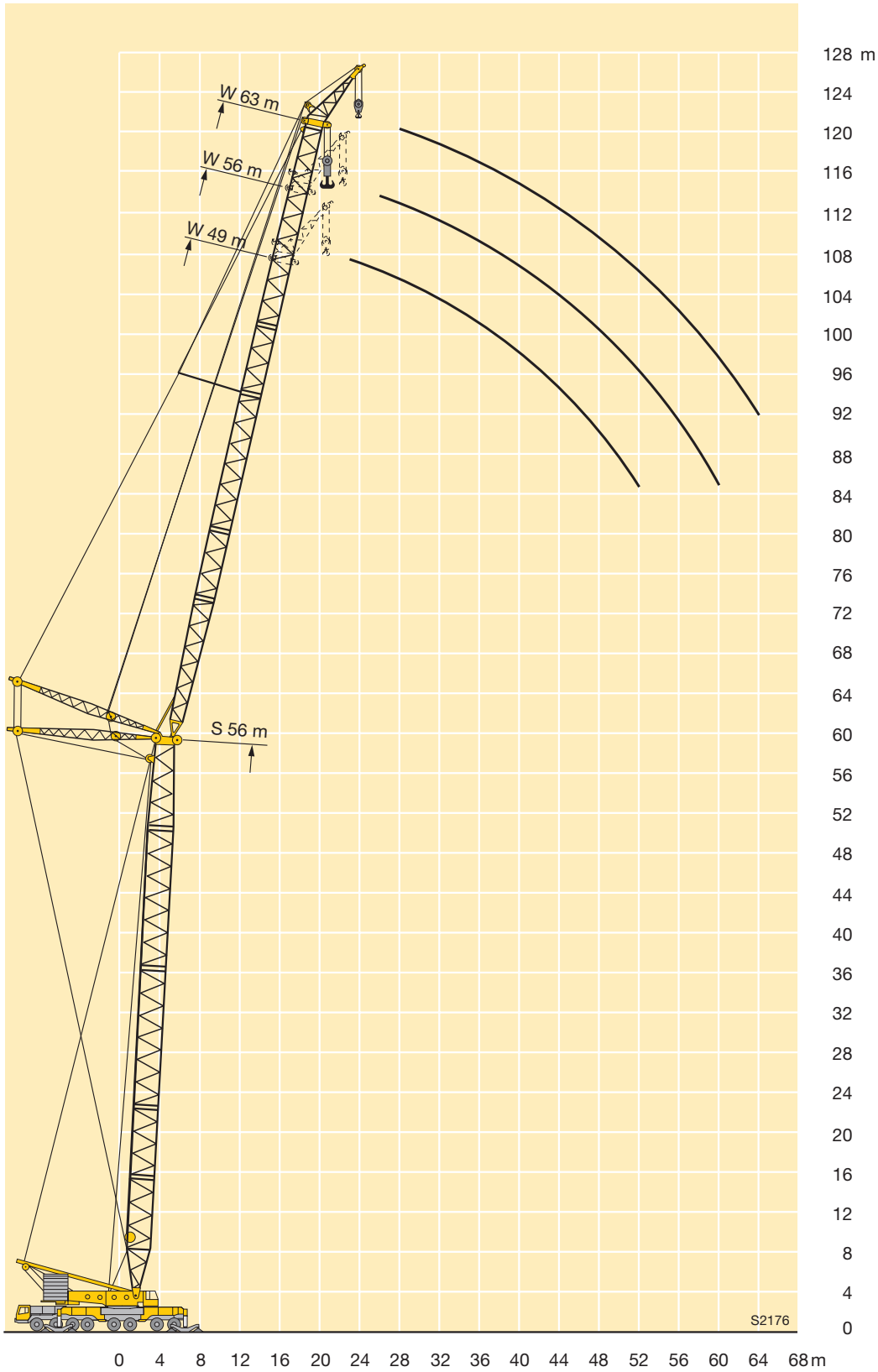

Traglasten am SW3H-Auslegersystem

Lifting capacities on SW3H boom/jib combination

Forces de levage en configuration SW3H



m	49 m					56 m			m
	56 m	63 m	70 m	77 m	84 m	49 m	56 m	63 m	
23						95			23
24						95			24
26	89	85				87	89		26
28	85	81	73			83	83	80	28
30	78	75	72	58		77	76	73	30
32	72	70	68	57	50	72	70	68	32
34	67	65	63	57	49	67	65	62	34
36	62	59	58	55	48,5	62	60	58	36
38	58	55	54	51	48	57	56	53	38
40	54	51	50	48,5	45,5	54	52	50	40
44	47	45	43	42	39,5	47	45,5	43	44
48	41	39	38	36,5	35	41,5	40	38	48
52	36,5	34,5	33	31,5	30,5	36,5	35	33	52
56	32	30	28,9	27,5	26,2		31,5	29,1	56
60	28,8	26,6	25,5	24,2	22,9		27,5	25,3	60
64		23,6	22,1	20,8	19,5			22,4	64
68			19,5	18,2	17				68
72			17,2	15,5	14,2				72
76				13,5	12,2				76
80					9,9				80

TAB 49306

Hubhöhen am SW3H-Auslegersystem
Lifting heights on SW3H boom/jib combination
Hauteurs de levage en configuration SW3H

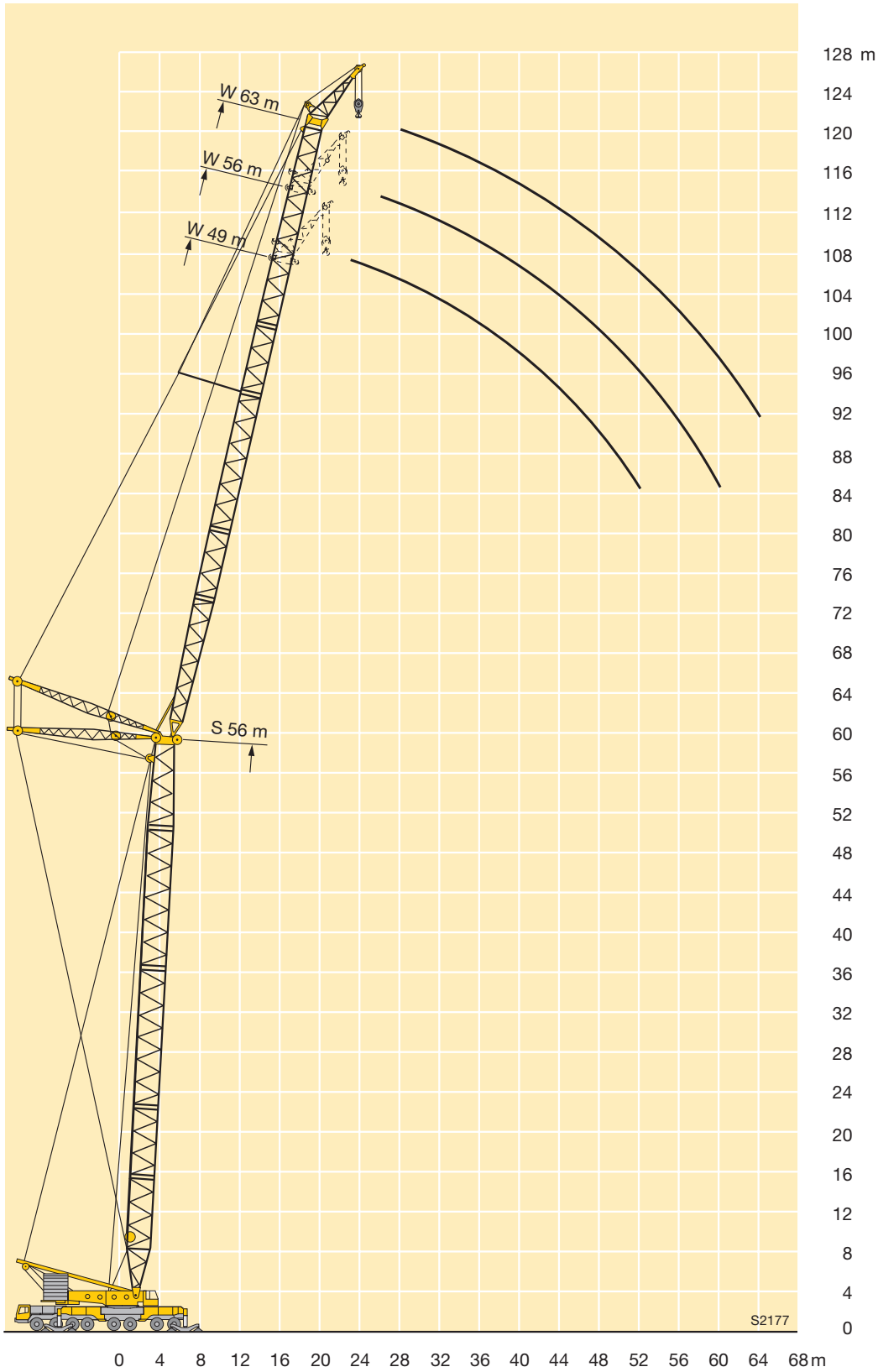

Traglasten am SDW-Auslegersystem

Lifting capacities on SDW boom/derrick/jib combination

Forces de levage en configuration SDW



m	35 m								42 m								m		
	28 m	35 m	42 m	49 m	56 m	63 m	70 m	77 m	84 m	28 m	35 m	42 m	49 m	56 m	63 m	70 m		77 m	84 m
14	199									197									14
16	173	173								172	171								16
18	153	153	152							152	152	149							18
20	137	137	136	135	132					136	135	133	132	129					20
22	124	123	122	121	119	103				122	122	120	118	116	98				22
24	113	112	111	110	108	101	88			111	111	109	107	105	96	83			24
26	103	103	101	100	98	97	86	74		102	101	99	98	96	94	82	70		26
28	95	94	93	92	90	89	85	73	62	94	93	91	90	88	86	80	69	59	28
30	88	87	86	85	83	81	80	72	61	86	86	84	83	81	79	77	68	58	30
32		81	79	78	77	75	74	70	60		79	78	76	75	73	71	67	57	32
34		75	74	73	71	70	68	66	59		74	72	71	69	68	66	64	56	34
36		70	69	68	66	65	63	61	58		69	67	66	65	63	61	59	55	36
38			64	63	62	60	59	57	55		65	63	62	60	59	57	55	53	38
40			61	59	58	56	55	53	51			59	58	56	55	53	51	49	40
44			54	52	51	49,5	48	46	44				52	51	49,5	48	46,5	44,5	44
48				47	45	43,5	42	40,5	38,5					45,5	44	42	40,5	39	48
52					40	39	37,5	35,5	33,5						39	37,5	36	34	52
56					36	34,5	33	31,5	29,5						35	33,5	32	29,9	56
60						31	29,5	27,7	25,8							29,9	28,2	26,3	60
64						28,1	26,4	24,5	22,6							26,9	25,2	23,2	64
68							23,7	21,7	19,9								22,5	20,5	68
72								19,3	17,3									18,1	72
76								17,2	15,1									16,1	76
80									13,1									11,9	80
84									11,3									10,1	84

TAB 49157

m	49 m								56 m								m		
	28 m	35 m	42 m	49 m	56 m	63 m	70 m	77 m	84 m	28 m	35 m	42 m	49 m	56 m	63 m	70 m		77 m	84 m
16	171									168									16
18	151	149	147							148	146	140							18
20	135	133	131	129						132	130	128	122						20
22	121	120	118	116	114					119	117	115	113	102					22
24	110	109	107	105	103	91				108	106	104	102	100	85				24
26	101	99	97	96	94	89	78			99	97	95	93	91	83	73			26
28	93	91	89	88	86	84	77	65		91	89	87	85	84	82	72	63		28
30	86	84	82	81	79	77	75	64	55	84	82	80	79	77	75	71	62	53	30
32		78	76	75	73	71	70	63	54	78	76	74	73	71	69	67	61	52	32
34		73	71	69	68	66	64	62	53		71	69	68	66	64	62	60	51	34
36		68	66	65	63	61	60	58	53		66	65	63	61	59	58	56	51	36
38		64	62	60	59	57	56	54	52		62	60	59	57	55	53	51	49,5	38
40			58	56	55	53	52	50	48				57	55	53	51	49,5	47,5	40
44			51	50	48	46,5	45	43	41,5				50	48,5	46,5	44,5	43	41,5	44
48				44,5	42,5	41	39,5	37,5	36					43	41,5	39,5	38	36	48
52					38	36,5	35	33	31					38,5	36,5	34,5	33	31,5	52
56					34	32,5	31	28,9	27						33	31	29,2	27,3	56
60						28,9	27,3	25,4	23,6							27,4	25,8	23,9	60
64						26	24,3	22,4	20,5							24,6	22,8	20,9	64
68							21,6	19,7	17,7								20,3	18,2	68
72								17,3	15,2									15,9	72
76								15,2	13									13,8	76
80									11									9,2	80
84									9,1									7,2	84

TAB 49157

Traglasten am SDW-Auslegersystem

Lifting capacities on SDW boom/derrick/jib combination

Forces de levage en configuration SDW



m	63 m								70 m								m
	35 m	42 m	49 m	56 m	63 m	70 m	77 m	84 m	35 m	42 m	49 m	56 m	63 m	70 m	77 m	84 m	
18	143								128								18
20	127	125							124	110							20
22	115	112	110						112	108	96						22
24	104	102	100	94					101	99	94						24
26	95	93	91	89	75				93	90	88	81	68				26
28	87	85	83	82	74	65			85	83	81	79	67	58			28
30	80	79	77	75	72	64	56		78	76	74	72	66	57	50		30
32	75	73	71	69	67	63	55	46	73	70	69	67	65	56	49,5	42	32
34	69	68	66	64	62	60	55	45,5	68	66	64	62	60	56	49	41,5	34
36	65	63	61	60	58	56	53	45	63	61	59	57	56	54	48	41	36
38	61	59	57	56	54	52	49,5	44,5	59	57	55	53	52	49,5	47,5	40,5	38
40		55	53	52	50	48,5	46	44		53	52	49,5	48	46	44	40	40
44		48,5	47	45,5	43,5	42	39,5	37,5		47	45,5	43,5	42	40	38	35,5	44
48			41,5	40	38	36,5	34	32			40	38	36,5	34,5	32,5	30	48
52			37,5	35,5	33,5	32	29,6	27,7			36	34	32,5	30	28,3	25,7	52
56				32	29,8	28,2	25,8	23,8				30	28,5	26,4	24,5	21,9	56
60					26,4	24,9	22,4	20,4					25,3	23,2	21,1	18,4	60
64					23,6	21,9	19,4	17,3					22,5	20,3	18,2	15,3	64
68						19,4	16,8	14,6						17,8	15,5	12,5	68
72						17,2	14,4	12						15,7	13,2	9,5	72
76							12,4	9,5							11	6,9	76
80								7,1								5,8	80
84								6,2								4,9	84

TAB 49157

m	77 m								m
	35 m	42 m	49 m	56 m	63 m	70 m	77 m	84 m	
20	110								20
22	108	95							22
24	99	93	82						24
26	90	88	81	70					26
28	83	80	79	69	60				28
30	76	74	72	68	59	50			30
32	71	68	67	65	58	49,5	43		32
34	66	64	62	60	58	49	42,5	37	34
36	61	59	58	55	53	48,5	42	36,5	36
38	57	55	54	52	49,5	47,5	41,5	36,5	38
40	54	52	50	48	46	44,5	41	36	40
44		45,5	44	42	40	38,5	36	34	44
48			39	37	35	33,5	30,5	28,7	48
52			34,5	32,5	30,5	29	26,4	24,4	52
56				29	26,9	25,3	22,7	20,6	56
60				25,9	23,7	22	19,3	17,1	60
64					21	19,2	16,4	14	64
68						16,7	13,7	10,9	68
72						14,6	11,2	7,1	72
76							8,7	5,9	76
80								4,9	80
84								4,1	84

TAB 49157

Hubhöhen am SDW-Auslegersystem
Lifting heights on SDW boom/derrick/jib combination
Hauteurs de levage en configuration SDW

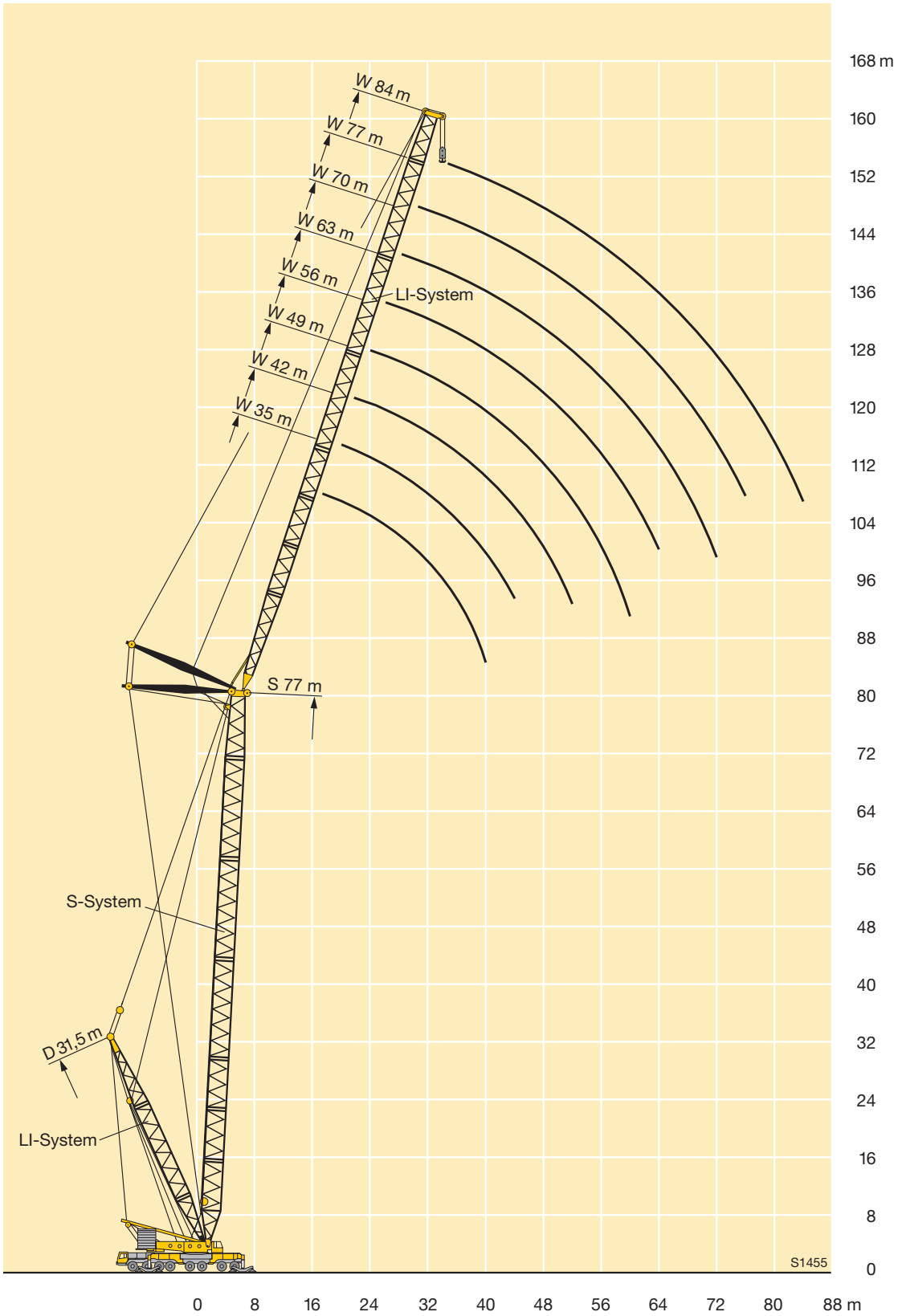

Traglasten am SDWB-Auslegersystem

Lifting capacities on SDWB boom/derrick/jib combination

Forces de levage en configuration SDWB



m	35 m										42 m								m
	28 m	35 m	42 m	49 m	56 m	63 m	70 m	77 m	84 m	28 m	35 m	42 m	49 m	56 m	63 m	70 m	77 m	84 m	
14	270									260									14
16	245	240								238	220								16
18	229	226	195							221	213	182							18
20	214	212	190	163	138					207	205	177	153	129					20
22	201	199	184	159	134	103				194	192	173	149	126	98				22
24	189	187	179	154	131	101	88			183	181	168	145	123	96	83			24
26	179	177	173	150	127	99	86	74		173	171	164	141	119	94	82	70		26
28	169	167	164	145	123	97	85	73	62	164	162	159	137	116	92	80	69	59	28
30	161	159	156	141	120	95	83	72	61	155	153	150	133	113	90	79	68	58	30
32		151	148	136	116	93	81	70	60		146	143	129	110	88	77	67	57	32
34		144	141	132	112	90	80	69	59		139	136	126	106	86	76	66	56	34
36		133	135	127	109	88	78	68	58		133	130	122	103	84	74	64	55	36
38			129	123	105	86	76	67	57		120	124	118	100	82	73	63	55	38
40			118	118	101	84	75	65	56			119	114	97	80	71	62	54	40
44			93	107	94	80	71	63	54			96	106	90	77	68	60	52	44
48				90	87	76	68	60	52				92	84	73	65	58	50	48
52					79	72	64	58	50					77	69	62	55	48	52
56					69	67	61	55	49					71	65	59	53	47	56
60						63	58	53	47						61	56	51	45	60
64						54	54	50	45						56	53	49	43	64
68							51	48	43							50	46	41	68
72								45	41								44	39	72
76								41	39								42	38	76
80									37									36	80
84									32									33	84

TAB 49155

m	49 m										56 m								m
	28 m	35 m	42 m	49 m	56 m	63 m	70 m	77 m	84 m	28 m	35 m	42 m	49 m	56 m	63 m	70 m	77 m	84 m	
16	215									180									16
18	208	190	168							176	158	140							18
20	201	185	164	143						171	155	137	122						20
22	190	180	160	140	117					167	151	135	120	102					22
24	178	175	156	136	114	91				163	148	132	118	100	85				24
26	169	166	153	133	111	89	78			158	144	129	115	98	83	73			26
28	159	157	149	130	109	87	77	65		153	141	127	113	96	82	72	63		28
30	151	149	145	127	106	86	75	64	55	146	137	124	111	94	80	71	62	53	30
32		142	138	123	103	84	74	63	54	138	134	121	109	92	79	69	61	52	32
34		135	132	120	100	82	72	62	53		130	118	107	90	77	68	60	51	34
36		129	126	116	98	80	71	61	53		124	116	105	88	76	67	59	51	36
38		121	120	113	95	78	69	60	52		119	113	102	86	74	66	58	50	38
40			115	109	92	77	68	59	51			110	100	84	73	64	57	49	40
44			97	102	87	73	65	57	49			99	96	80	70	62	55	48	44
48				92	81	69	62	55	48				91	76	66	59	53	46	48
52					76	66	59	53	46				75	72	63	57	52	44	52
56					70	62	57	51	44					68	60	54	50	43	56
60						59	54	49	43						57	52	48	41	60
64						55	51	47	41						54	49	46	40	64
68							48	45	40							47	44	38	68
72								43	38								42	37	72
76								41	36								40	35	76
80									35									34	80
84									32									32	84

TAB 49155

Traglasten am SDWB-Auslegersystem

Lifting capacities on SDWB boom/derrick/jib combination

Forces de levage en configuration SDWB



m	63 m								70 m								m
	35 m	42 m	49 m	56 m	63 m	70 m	77 m	84 m	35 m	42 m	49 m	56 m	63 m	70 m	77 m	84 m	
18	145								128								18
20	141	125							125	110							20
22	137	122	110						121	108	96						22
24	133	119	108	94					118	105	94	82					24
26	129	116	106	92	75				115	103	93	81	68				26
28	125	113	104	90	74	65			112	100	91	79	67	58			28
30	121	110	101	89	72	64	56		108	98	89	78	66	57	50		30
32	117	108	99	87	71	63	55	46	105	96	88	77	65	56	49	42	32
34	113	105	97	85	70	62	55	46	102	93	86	75	64	56	49	42	34
36	109	102	95	83	69	61	54	45	98	91	84	74	63	55	48	41	36
38	105	99	93	81	67	60	53	45	95	88	83	72	62	54	48	41	38
40		96	91	80	66	59	53	44		86	81	71	61	53	47	40	40
44		90	87	76	64	57	51	43		81	78	68	59	52	46	39	44
48			82	72	61	55	50	42			74	66	56	50	45	38	48
52			78	69	59	54	48	41			71	63	54	49	43	37	52
56				65	56	52	47	40				60	52	47	42	36	56
60					54	50	46	39					50	46	41	36	60
64					51	48	44	38					48	44	40	35	64
68						46	43	37						43	38	34	68
72						44	41	36						41	37	33	72
76							40	35							36	32	76
80								33								31	80
84								32								30	84

TAB 49155

m	77 m								m
	35 m	42 m	49 m	56 m	63 m	70 m	77 m	84 m	
20	110								20
22	108	95							22
24	105	93	82						24
26	103	91	81	70					26
28	100	89	79	69	60				28
30	98	87	78	68	59	50			30
32	95	85	77	67	58	49	43		32
34	93	82	76	66	58	49	43	37	34
36	90	80	74	66	57	48	42	37	36
38	88	78	73	65	56	48	42	36	38
40	85	76	72	64	55	47	41	36	40
44		72	69	62	53	46	40	35	44
48			67	60	52	45	39	34	48
52			64	59	50	44	38	34	52
56				57	48	43	37	33	56
60				55	47	41	36	32	60
64					45	40	35	32	64
68						39	34	31	68
72						38	33	30	72
76							32	29	76
80								29	80
84								28	84

TAB 49155

Hubhöhen am SDWB-Auslegersystem
Lifting heights on SDWB boom/derrick/jib combination
Hauteurs de levage en configuration SDWB

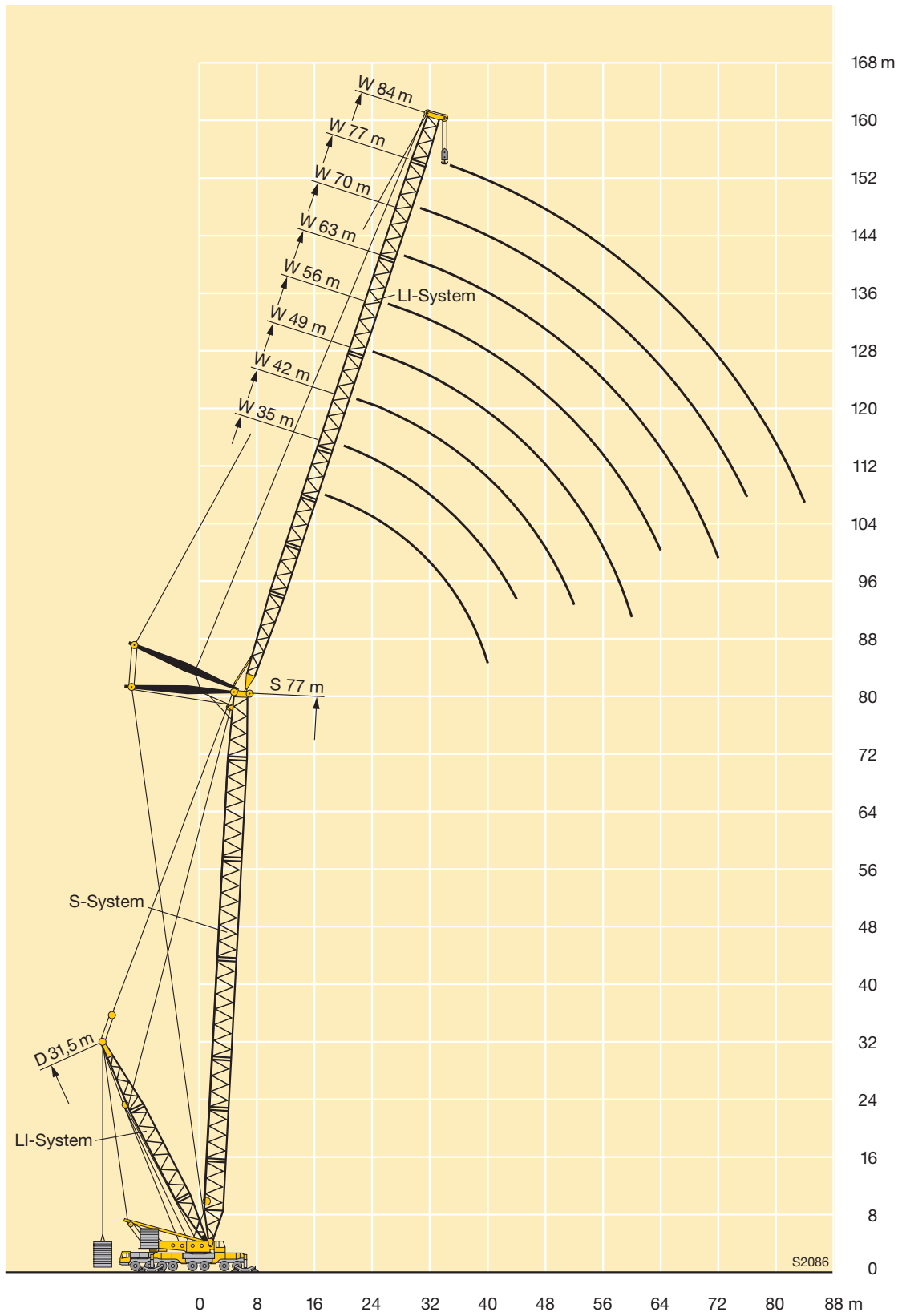

Traglasten am SDWB-Auslegersystem

Lifting capacities on SDWB boom/derrick/jib combination

Forces de levage en configuration SDWB



m	35 m								42 m								m		
	28 m	35 m	42 m	49 m	56 m	63 m	70 m	77 m	84 m	28 m	35 m	42 m	49 m	56 m	63 m	70 m		77 m	84 m
34	130																		34
36	122																		36
38	117	115								110									38
40	112	110								105									40
44	103	101	99							97									44
48		94	91	89						88	90								48
52			84	83	83					82	82	81							52
56			78	77	75	74					75	74	72						56
60				71	69	67	66				69	68	66	64	62				60
64				65	63	61	60	59				62	60	58	57	56			64
68					58	56	55	54	48					55	53	52	51	47	68
72					54	52	51	49	47					51	49	48	46	44	72
76						48	47	45	43						45	44	43	40	76
80							43	42	40						42	41	39	37	80
84							40	39	36							38	36	34	84
88								36	34							35	33	31	88
92								33	31								31	29	92
96									29									27	96
100									27									25	100

TAB 49156

m	49 m								56 m								m		
	28 m	35 m	42 m	49 m	56 m	63 m	70 m	77 m	84 m	28 m	35 m	42 m	49 m	56 m	63 m	70 m		77 m	84 m
40	105																		40
44	97	96								92									44
48	89	88	86							84	83								48
52		82	79	78						78	77	74							52
56		74	72	71	69						71	69	67						56
60			66	65	63	61						63	61	59					60
64				60	58	56	54					57	56	54	52				64
68				55	53	51	50	48					52	50	48	46			68
72					49	47	45	44	42				48	46	44	42	41		72
76					45	43	42	40	38					42	40	39	37	35	76
80						40	39	37	35					39	37	36	34	32	80
84						37	36	34	32						34	33	31	29	84
88							33	31	29							30	29	26	88
92								29	27							28	26	24	92
96								27	24								24	22	96
100									22								22	20	100
104									21									18	104
108																		17	108

TAB 49156

Traglasten am SDWB-Auslegersystem

Lifting capacities on SDWB boom/derrick/jib combination

Forces de levage en configuration SDWB



m	63 m								70 m								m
	35 m	42 m	49 m	56 m	63 m	70 m	77 m	84 m	35 m	42 m	49 m	56 m	63 m	70 m	77 m	84 m	
52	73																52
56	68	66							63	61							56
60	62	60	59						58	57	55						60
64		55	54						53	52	50	48					64
68		51	49	47	45					47	46	44	42				68
72			45	43	42	40					42	40	38	36			72
76			42	40	38	36	35				39	37	35	33	31		76
80				37	35	33	31	29				34	32	30	28	26	80
84					32	30	29	27				31	29	27	26	23	84
88					30	28	26	24					27	25	23	21	88
92							26	24	22				25	23	21	19	92
96							24	22	20					21	19	17	96
100								20	18						17	15	100
104								18	16						16	14	104
108									15							12	108
112																11	112

TAB 49156

m	77 m								m
	35 m	42 m	49 m	56 m	63 m	70 m	77 m	84 m	
56	59								56
60	55	53							60
64	50	48	47						64
68		44	43	41					68
72		40	39	37	36				72
76			36	34	32	30			76
80			33	31	30	28	26		80
84				29	27	25	24	21	84
88				26	25	23	21	19	88
92					23	21	19	17	92
96						19	17	15	96
100						17	16	14	100
104							14	12	104
108							13	11	108
112								9	112
116								8	116

TAB 49156

Hubhöhen am SDWB-Auslegersystem
Lifting heights on SDWB boom/derrick/jib combination
Hauteurs de levage en configuration SDWB

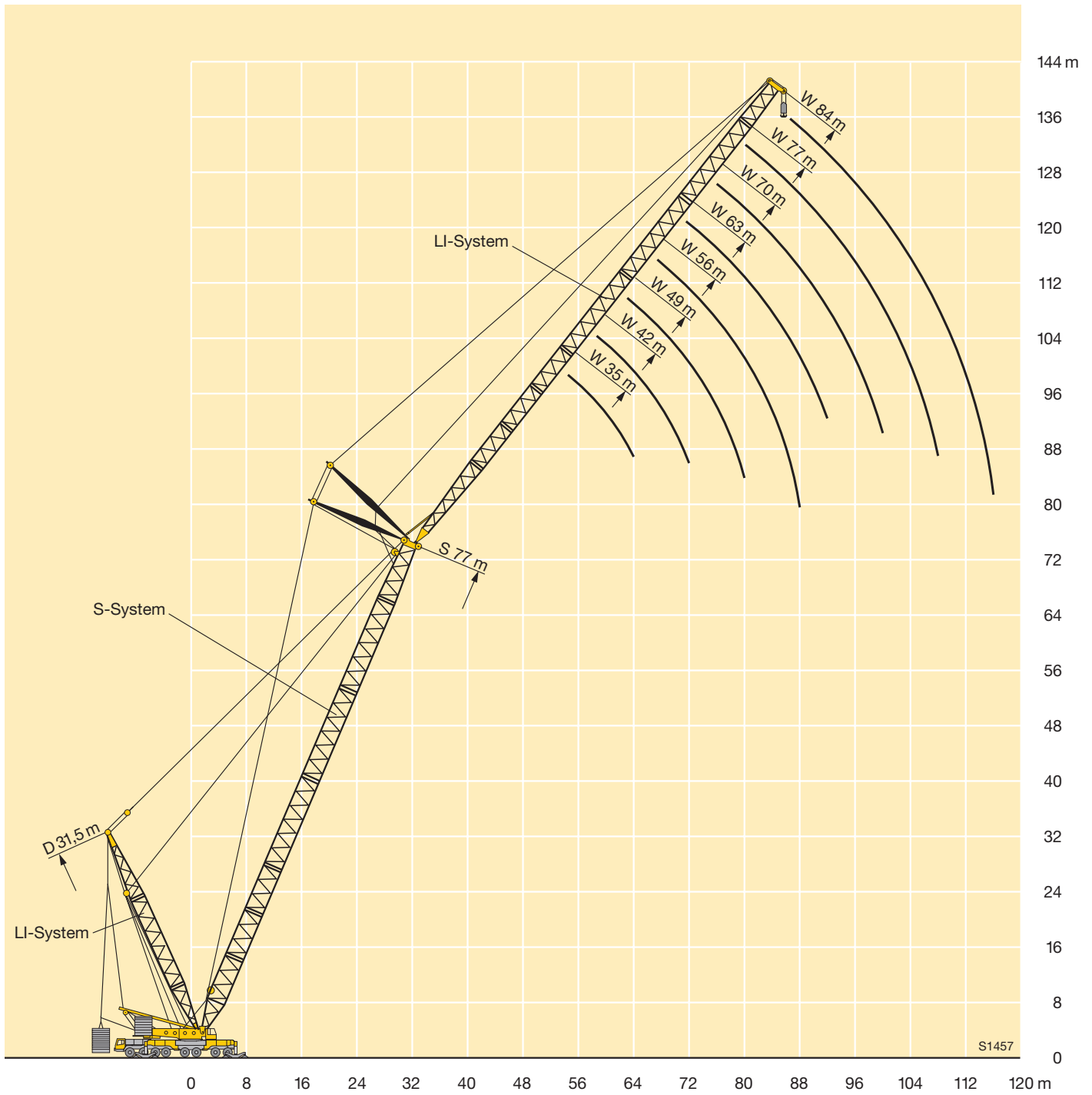

Traglasten am SWN-Auslegersystem

Lifting capacities on SWN boom/jib combination

Forces de levage en configuration SWN



m	28 m	35 m	42 m	49 m	m
	105 m	105 m	105 m	105 m	
34	39	37,5	36,5	35	34
36	38	37	36	34,5	36
38	37,5	36	35	33,5	38
40	36,5	35,5	34,5	33	40
44	35,5	34	33	31,5	44
48	34	32,5	31,5	30	48
52	32,5	31,5	30	28,7	52
56	31	29,9	28,8	27,3	56
60	28,5	27,2	25,9	24,5	60
64	25,3	24,1	22,9	21,5	64
68	22,5	21,4	20,2	18,9	68
72	20	19	17,8	16,5	72
76	17,9	16,8	15,6	14,3	76
80	15,8	14,8	13,6	12,3	80
84	14	12,9	11,8	10,4	84
88	12,3	11,2	10,1	8,5	88
92	10,7	9,6	8,4	7	92
96	9,3	8,2	7	6,1	96
100	7,9	7	6,2	5,4	100

TAB 49175

Hubhöhen am SWN-Auslegersystem
Lifting heights on SWN boom/derrick/jib combination
Hauteurs de levage en configuration SWN

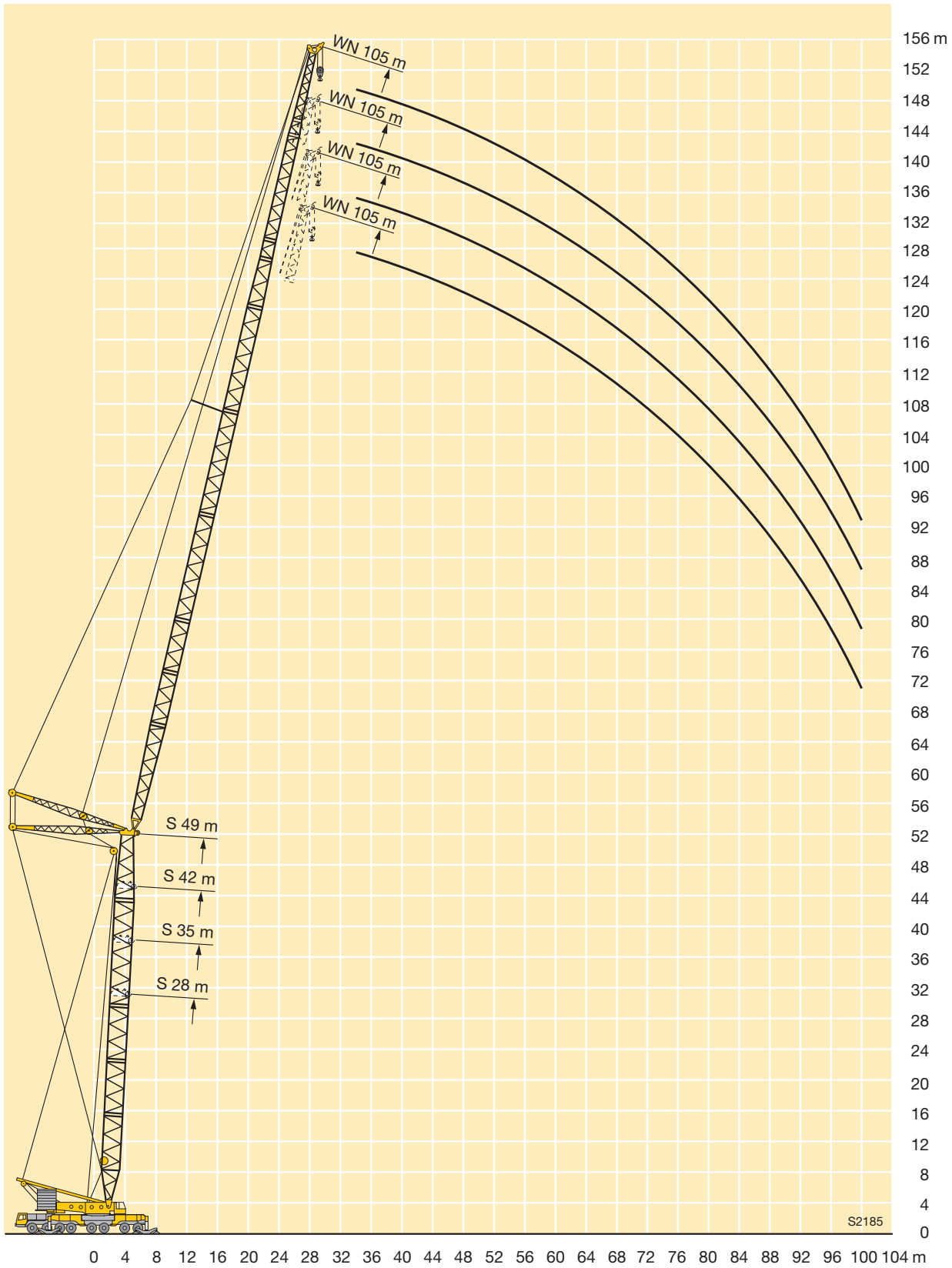

Anmerkungen zu den Traglasttabellen

1. Die angegebenen Traglasten überschreiten nicht 75% der Kipplast.
2. Für die Kranberechnungen gelten die DINVorschriften lt. Gesetz gemäß Bundesarbeitsblatt vom 2/85: Die Traglasten 75% (Standssicherheit) entsprechen DIN 15019, Teil 2. Für die Stahltragwerke gilt DIN 15018, Teil 3. Die bauliche Ausbildung des Krans entspricht DIN 15018, Teil 2 sowie der F.E.M.
3. Die Traglasten sind in Tonnen angegeben.
4. Das Gewicht des Lasthakens bzw. der Hakenflasche ist von den Traglasten abzuziehen.
5. Die Ausladungen sind von Mitte Drehkranz gemessen.
6. Traglastwerte mit verringerter Abstützbasis auf Anfrage.
7. Die max. Traglast des Krans kann – je nach Ländervorschrift bezüglich der zulässigen Seilsicherheit – niedriger sein.
8. Bei Kranbetrieb mit wippbarer Gitterspitze wurde Windstärke 5 = 50 N/m² berücksichtigt.

Remarks referring to load charts

1. The tabulated lifting capacities do not exceed 75% of the tipping load.
2. When calculating crane stresses and loads, German Industrial Standards (DIN) are applicable, in conformity with German legislation (published 2/85): the 75% lifting capacities (stability margin) are as laid down in DIN 15019, part 2. The crane's structural steelwork is in accordance with DIN 15018, part 3. Design and construction of the crane comply with DIN 15018, part 2, and with F.E.M. regulations.
3. Lifting capacities are given in metric tons.
4. The weight of the hook blocks and hooks must be deducted from the lifting capacities.
5. Working radii are measured from the slewing centreline.
6. Lifting capacities with reduced support base on request.
7. The max. lifting capacity of the cranes may be reduced dependent on the admissible rope safety regulations of a country.
8. For crane operation with luffing jib, wind force 5 = 50 N/m² has been allowed for.

Remarques relatives aux tableaux des charges

1. Les forces de levage indiquées ne dépassent pas 75% de la charge de basculement.
2. Conformément au texte de loi paru au bulletin fédéral de février 1985, les normes DIN ci-après sont appliquées pour les calculs relatifs à la grue: charges à 75% suivant les prescriptions de la norme DIN 15019, 2ème partie. La norme DIN 15018, 3ème partie est appliquée pour les charpentes. La construction de la grue est réalisée conformément à la norme DIN 15018, 2ème partie, et aux règles de la F.E.M.
3. Les forces de levage sont données en tonnes.
4. Le poids des moufles et crochets doit être soustrait des charges indiquées.
5. Les portées sont calculées à partir de l'axe de rotation.
6. Forces de levage avec base d'appui réduite sur demande.
7. La capacité de charge de la grue peut être réduite en fonction des spécifications de sécurité de câbles d'un pays.
8. Pour service avec flèche à volée variable, la force du vent 5 = 50 N/m² a été prise en considération.

Liebherr-Werk Ehingen GmbH

Postfach 1361, 89582 Ehingen, Germany

☎ +49 73 91 5 02-0, Fax +49 73 91 5 02-33 99

www.liebherr.com, E-mail: info.lwe@liebherr.com